

3.1 INTRODUCTION

Wood differs from other construction materials because it is produced in a living tree. As a result, wood possesses material properties that may be significantly different from other materials normally encountered in structural design. Although it is not necessary to have an in-depth knowledge of wood anatomy and properties, it is necessary for the engineer to have a general understanding of the properties and characteristics that affect the strength and performance of wood in bridge applications. This includes not only the anatomical, physical, and mechanical properties of wood as a material, but also the standards and practices related to the manufacture of structural wood products, such as sawn lumber and glulam.

In the broadest terms, trees and their respective lumber are classified into two general classes, hardwoods and softwoods. Hardwoods normally have broad leaves that are shed at the end of each growing season. Softwoods have needlelike leaves that normally remain green year round. The classification as hardwood or softwood has little to do with the comparative hardness of the wood. Several species of softwoods are harder than many low- to medium-density hardwoods. With few exceptions the structural wood products used in bridge applications throughout North America are manufactured primarily from softwoods. Although hardwoods are not widely used at this time, structural grading procedures for hardwoods have been developed recently, and their use is increasing in some regions of the country.

This chapter discusses the structure of wood, its physical and mechanical properties, and the manufacturing and grading processes for sawn lumber and glulam. The scope of coverage is limited to softwood species, although many of the general characteristics are applicable to hardwoods. Additional information on wood properties and characteristics is given in references listed at the end of this chapter.

3.2 STRUCTURE OF WOOD

To fully understand and appreciate wood as a structural material, one must first understand wood anatomy and structure. This can be considered at two levels: the microstructure, which can be examined only with the aid of

a microscope, and the macrostructure, which is normally visible to the unaided eye.

MICROSTRUCTURE

The primary structural building block of wood is the wood cell, or tracheid. When closely packed, these wood cells form a strong composite system that is often compared to a bundle of drinking straws (Figure 3-1). As a unit, the straws (wood cells) weigh very little, but if restrained from lateral buckling, they will support a substantial load in compression parallel to their longitudinal axis. If the straws are loaded in compression perpendicular to their longitudinal axis, they will yield under relatively light loads. Using this analogy, it is easy to visualize the superior strength-to-weight ratio of a cellular composite such as wood. Yet, each individual wood cell is even more structurally advanced because it is actually a multilayered, filament-reinforced, closed-end tube rather than just a homogeneous, nonreinforced straw (Figure 3-2).

MACROSTRUCTURE

The cross section of a tree can be divided into three basic parts: bark, cambium, and wood (Figure 3-3). Bark is the exterior layer and is composed of an outer layer of corky material with a thin inner layer of living

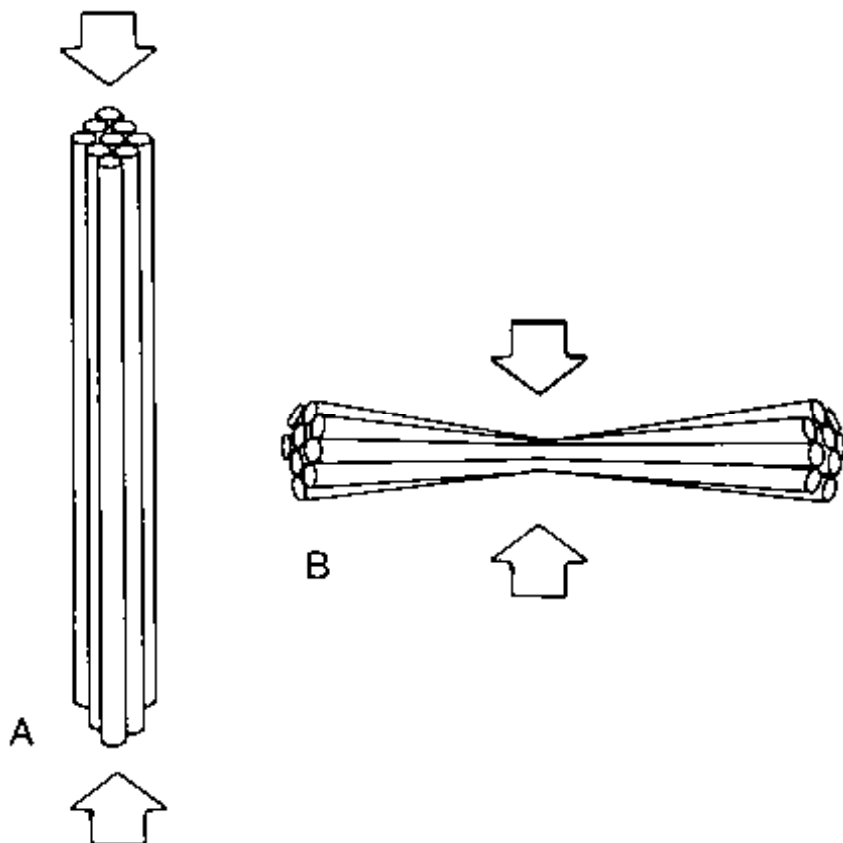

Figure 3-1.- Simplified depiction of the structure of wood, comparing it to a bundle of thin-walled drinking straws. (A) Parallel to their longitudinal axis, the straws (wood cells) can support loads substantially greater than their weight. (B) When loaded perpendicular to their longitudinal axis, the straws yield under much lower loads.

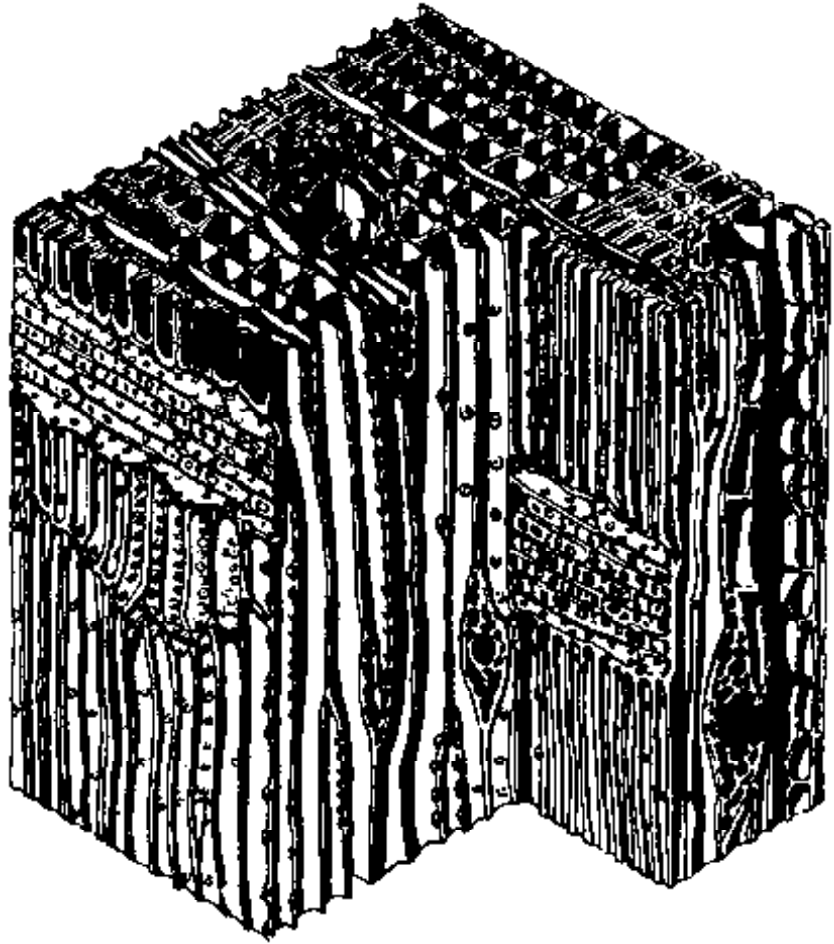

Figure 3-2.- Drawing of the magnified structure of a softwood.

cells. It functions to protect the tree and to conduct nutrients. The cambium is a thin, continuous ring of reproductive tissue located between the wood and the bark. It is the only portion of the tree where new wood and bark cells are formed and is usually only one to ten cells thick, depending on the season of the year. All material inside the cambium layer is wood, which conducts and stores nutrients and provides the tree with structural support. At the center of the wood, where tree growth began, is the pith or heart center.

Wood is divided into two general classes, sapwood and heartwood. The sapwood consists of both active and inactive cells and is located on the outside of the tree, next to the cambium. It functions primarily in food storage and the transport of sap. The radial thickness of sapwood is commonly 1-1/2 to 2 inches for most species, but it may be 3 to 6 inches thick for some species. Heartwood, which was once sapwood, is composed mostly of inactive cells that differ both chemically and physically from sapwood cells. The heartwood cells do not function in either food storage or sap transportation. In most species, the heartwood contains extractive

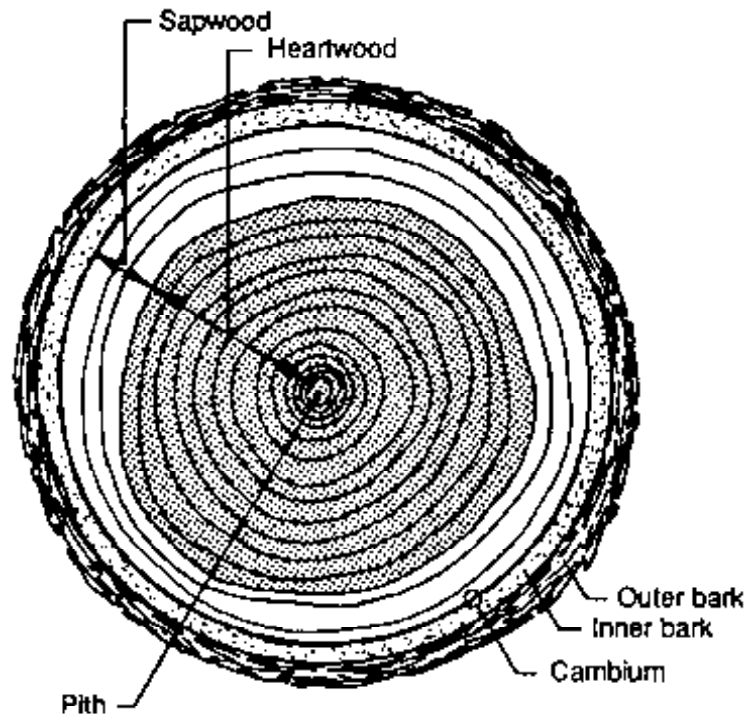

Figure 3-3.- Tree cross section showing elements of the macrostructure that are normally visible without magnification.

substances that are deposited in the cell during the conversion from sapwood to heartwood. These deposits frequently give the heartwood a much darker color than sapwood; however, in several species the heartwood is not dark and looks virtually the same as sapwood. The extractives also serve to make the heartwood of several species more resistant to attack by decay fungi and insects. Because all heartwood was once sapwood, there is generally little difference in their dry weight or strength.

Growth in wood cells varies between cells that are formed early in the growing season, earlywood cells, and those formed late in the growing season, latewood cells. Earlywood cells are usually formed during the first or second month of the growing season and have relatively large cell cavities and thin walls. Latewood cells are formed later in the growing season and have smaller cell cavities and thicker walls. The contrast between the earlywood and latewood cells forms the characteristic growth rings common to most species (Figure 3-4). These growth rings vary in width, depending on species and site conditions. In many species of softwood, such as Douglas-fir and Southern Pine, there is a marked contrast between the earlywood and latewood, and growth rings are plainly visible. In other species, such as spruces and true firs, the change from earlywood to latewood is less obvious, and rings are more difficult to see. Environmental conditions can also affect growth rings. Rings formed

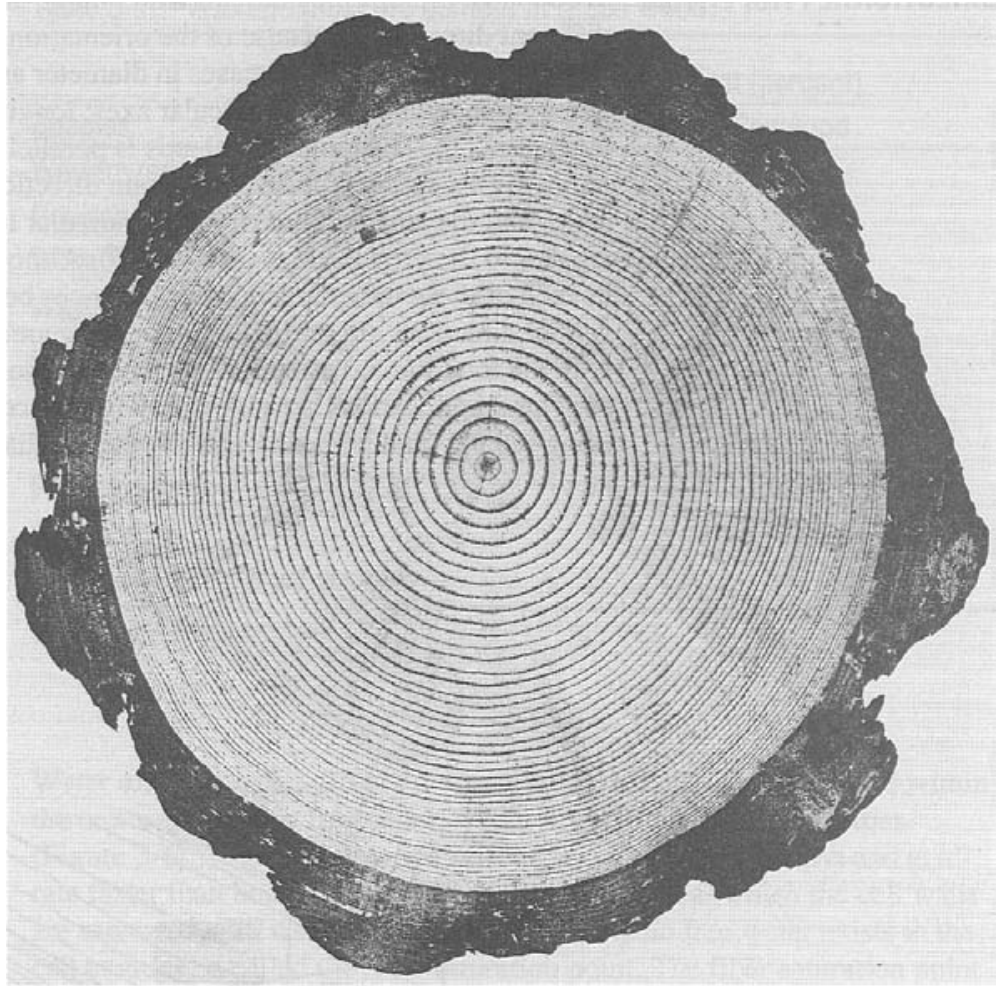

Figure 3-4.- Cross section of a pine log showing growth rings. Light bands are earlywood, dark bands are latewood. A growth ring is composed of the earlywood ring and the latewood ring outside it.

during short or dry seasons are narrower than those formed under more favorable growing conditions.

3.3 PHYSICAL PROPERTIES OF WOOD

Physical properties describe the quantitative characteristics of wood and its behavior to external influences other than applied forces. Included are such properties as moisture content, density, dimensional stability, thermal and pyrolytic (fire) properties, natural durability, and chemical resistance. Familiarity with physical properties is important because those properties can significantly influence the performance and strength of wood used in structural applications.

DIRECTIONAL PROPERTIES Wood is an orthotropic material with unique and independent properties in different directions. Because of the orientation of the wood fibers, and the manner in which a tree increases in diameter as it grows, properties vary along three mutually perpendicular axes: longitudinal (L), radial (R), and tangential (T). The longitudinal axis is parallel to the grain direction, the radial axis is perpendicular to the grain direction and normal to the growth rings, and the tangential axis is perpendicular to the grain direction and tangent to the growth rings (Figure 3-5). Although wood properties differ in each of these three directions, differences between the radial and tangential directions are normally minor compared to their mutual differences with the longitudinal direction. As a result, most wood properties for structural applications are given only for directions parallel to grain (longitudinal) and perpendicular to grain (radial and tangential).

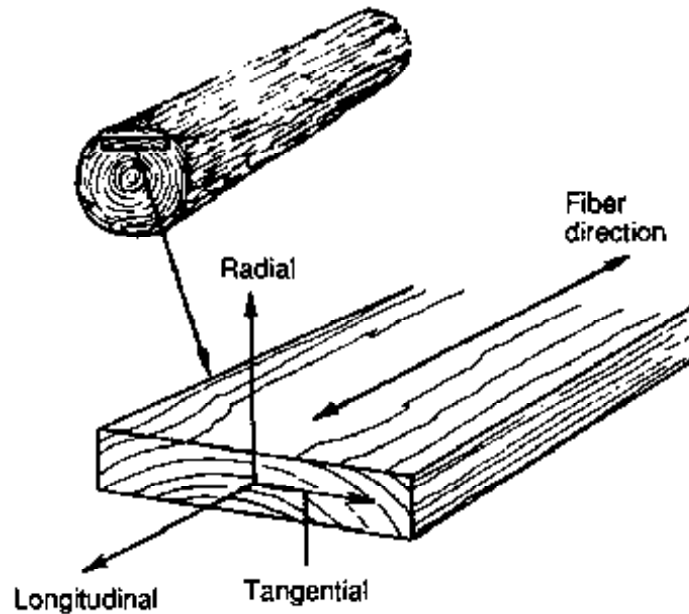

Figure 3-5- The three principal axes of wood with respect to grain direction and growth rings.

MOISTURE CONTENT

The moisture content of wood (MC) is defined as the weight of water in wood given as a percentage of oven-dry weight:

$$MC = \frac{\text{moist weight} - \text{oven-dry weight}}{\text{oven-dry weight}} \times 100 \text{ percent} \quad (3-1)$$

In living trees, water is required for growth and development, and water constitutes a major portion of green wood. Depending on the species and type of wood, the moisture content of living wood ranges from approximately 30 percent to more than 250 percent (two-and-a-half times the weight of the solid wood material). In most species, the moisture content of the sapwood is higher than that of the heartwood (Table 3-1).

Table 3-1.-Average moisture content of green wood.

Species	Moisture content (percent)	
	Heartwood	Sapwood
Western redcedar	58	249
Douglas-fir (coast)	37	115
White fir	98	160
Western hemlock	85	170
Eastern hemlock	97	119
Larch (western)	54	110
Loblolly pine	33	110
Ponderosa pine	40	148
Sitka spruce	41	142
Average of 27 softwood species	55	149

From *Wood Handbook*.³⁹

Water exists in wood as bound water, which is molecularly bonded within the cell walls, and as free water, which is present in the cell cavities (Figure 3-6). When moist wood dries, free water separates first and at a rate faster than bound water. The moisture content at which the cell walls are saturated with water, but at which virtually no free water exists in the cell cavities, is called the fiber saturation point. The fiber saturation point for most woods averages about 30 percent, but may vary by a few percentage points among different species.

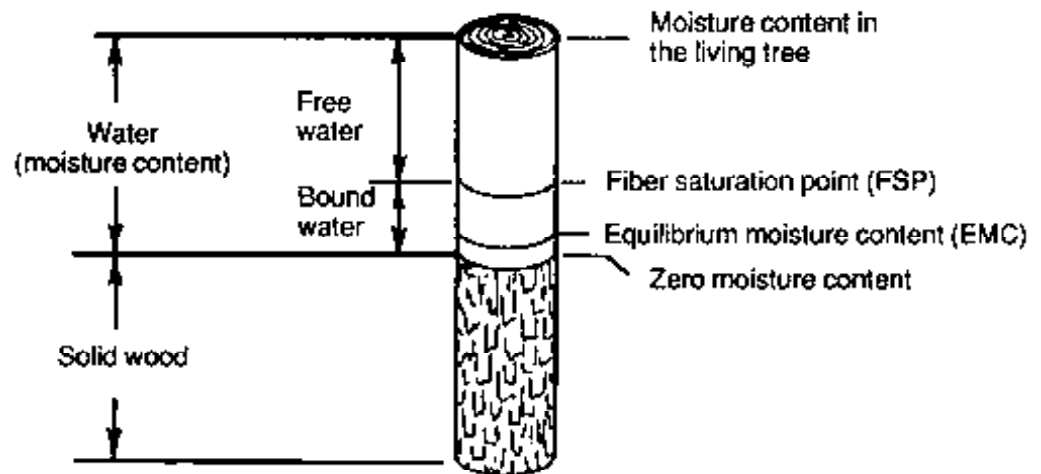

Figure 3-6.- Diagrammatic representation of wood moisture content.

Wood is a hygroscopic material that absorbs moisture in humid environments and loses moisture in dry environments. Therefore, the moisture content of wood is a result of atmospheric conditions and depends on the relative humidity and temperature of the surrounding air. Under constant temperature and humidity conditions, an equilibrium moisture content (EMC) is reached. The equilibrium moisture content represents a balance point where the wood is neither gaining nor losing moisture and is in equilibrium with the environment. In bridge applications, wood moisture content is almost always undergoing some changes as temperature and humidity conditions vary. These changes are usually gradual, short-term fluctuations that influence only the wood surface. Over a period of time, however, the wood will approach an equilibrium moisture content related to the environment. The time required to reach the equilibrium moisture content depends on the size and permeability of the member, the temperature, and the difference between the initial moisture content of the wood and the eventual equilibrium moisture content for the environment. The relationship between equilibrium moisture content, relative humidity, and temperature is generally independent of species and is shown in Table 3-2.

Table 3-2.- Moisture content of wood in equilibrium with stated dry-bulb temperature and relative humidity.

Temperature (dry-bulb)	Moisture content at various relative humidities (percent)										
	10	20	30	40	50	60	70	80	90	95	98
30	2.6	4.6	6.3	7.9	9.5	11.3	13.5	16.5	21.0	24.3	26.9
40	2.6	4.6	6.3	7.9	9.5	11.3	13.5	16.5	21.0	24.3	26.9
50	2.6	4.6	6.3	7.9	9.5	11.2	13.5	16.5	20.9	24.3	26.9
60	2.5	4.6	6.2	7.8	9.4	11.1	13.3	16.2	20.7	24.1	26.8
70	2.5	4.5	6.2	7.7	9.2	11.0	13.1	16.0	20.5	23.9	26.6
80	2.4	4.4	6.1	7.6	9.1	10.8	12.9	15.7	20.2	23.6	26.3
90	2.3	4.3	5.9	7.4	8.9	10.5	12.6	15.4	19.8	23.3	26.0
100	2.3	4.2	5.8	7.2	8.7	10.3	12.3	15.1	19.5	22.9	25.6
110	2.2	4.0	5.6	7.0	8.4	10.0	12.0	14.7	19.1	22.4	25.2
120	2.1	3.9	5.4	6.8	8.2	9.7	11.7	14.4	18.6	22.0	24.7

From *Wood Handbook*.²⁶

DIMENSIONAL STABILITY

Wood is dimensionally stable when the moisture content is above the fiber saturation point. Below the fiber saturation point, wood shrinks when moisture is lost and swells when moisture is gained. This susceptibility to dimensional change is one of the few wood properties that exhibit significant differences for the three orthotropic axes. In the longitudinal direction, average shrinkage values from green to oven-dry conditions are between 0.1 and 0.2 percent, which is generally of no practical concern. In

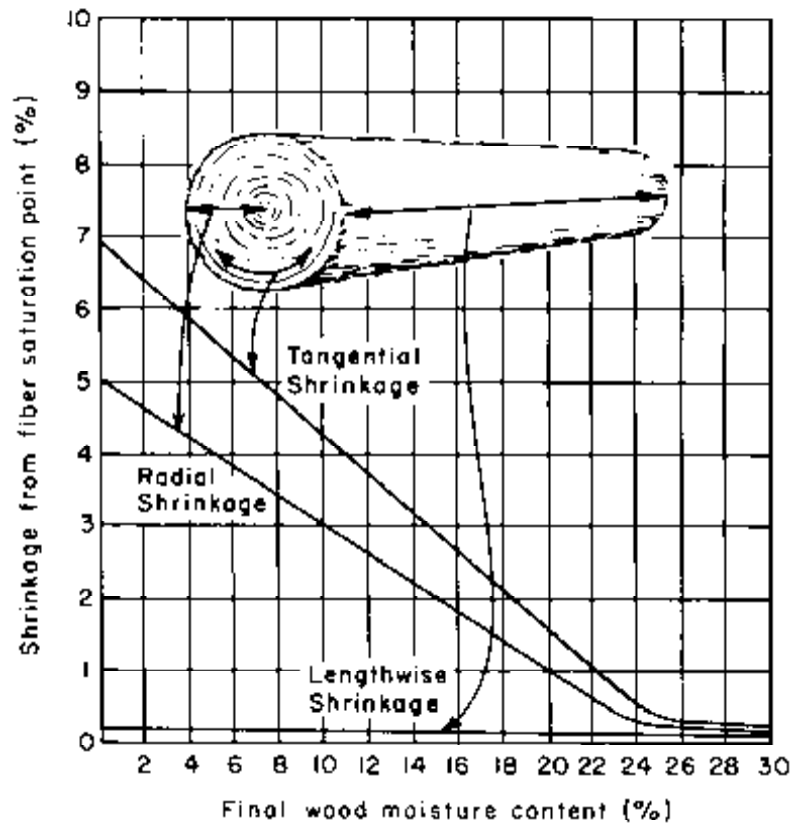

Figure 3-7.- Approximate wood shrinkage relationships below the fiber saturation point for the three orthotropic axes (adapted from the Canadian Wood Council¹³). Used by permission.

the tangential and radial directions, however, shrinkage is much more pronounced (Figure 3-7).

Wood shrinkage is approximately a linear function of moisture content, and dimensional changes below approximately 24 percent can be determined with reasonable accuracy. An example of shrinkage calculations based on the values given in Figure 3-7 is shown in Example 3-1. More accurate methods for computing shrinkage are given in the *Wood Handbook*.³⁰ Although formal shrinkage calculations are normally not required in structural design, the designer must be aware that wood is not a static material and that dimensional changes occur.

Example 3-1- Wood shrinkage from a decrease in moisture content

Determine the approximate changes in depth and width occurring when the wood member shown below dries from an initial moisture content of 28 percent to an equilibrium moisture content of 18 percent.

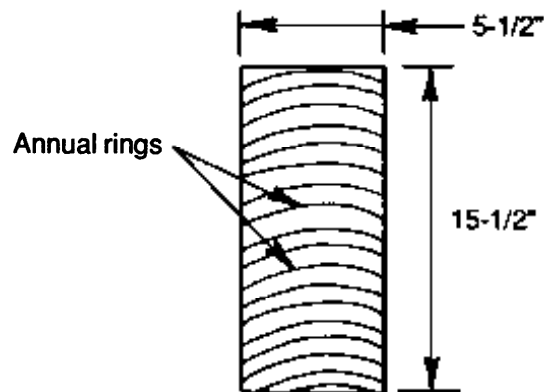

Dimensions at 28% MC

Solution

The orientation of the annual rings is approximately parallel with the narrow face of the member. Therefore, shrinkage in the tangential direction will affect member width, while shrinkage in the radial direction will affect member depth.

Approximate dimensional changes between two moisture contents are obtained from Figure 3-7. In the radial direction, shrinkage from fiber saturation to 28-percent moisture content is approximately 0.2 percent. At M-percent moisture content, the change is approximately 1.4 percent. The percent shrinkage in the radial direction between 28-percent and 18-percent moisture content is the difference between the two values:

$$\text{Percent radial shrinkage} = 1.4\% - 0.2\% = 1.2\%$$

Applying the percentage shrinkage to the dimension at 28-percent moisture content gives the shrinkage in inches:

$$\text{Radial shrinkage} = 0.012(15.5 \text{ in.}) = 0.2 \text{ in.}$$

Shrinkage in the tangential direction is determined in the same manner. From fiber saturation, tangential shrinkage is approximately 0.3 percent at 28-percent moisture content and 2.1 percent at 18-percent moisture content:

$$\text{Percent tangential shrinkage} = 2.1\% - 0.3\% = 1.8\%$$

$$\text{Tangential shrinkage} = 0.018(5.5 \text{ in.}) = 0.1 \text{ in.}$$

In summary, the member will shrink about 0.2 inch in depth and 0.1 inch in width.

The effects of uneven drying plus shrinkage differences in the tangential and radial direction can cause wood pieces to distort or warp (Figure 3-8). In addition, the uncontrolled drying or seasoning of wood frequently causes lengthwise separations of the wood across the annual rings, commonly known as checks (Figure 3-9). Most checks are not of structural significance; however, when checking extends from one surface to the opposite or adjoining surface (through-checks) the strength and other properties of the piece may be affected.

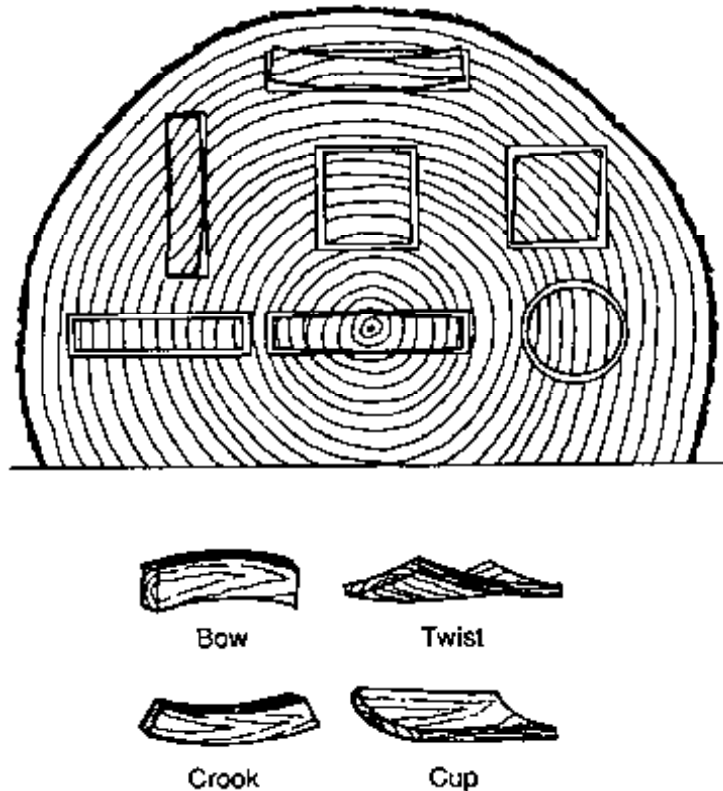

Figure 3-8.- Characteristic shrinkage and distortion of wood as affected by the direction of the growth rings. Such distortion can result in warp, which is generally classified as bow, twist, crook, and cup.

DENSITY

The density of a material is defined as the mass per unit volume at some specified condition. For a hygroscopic material such as wood, density depends on two factors, the weight of the basic wood substance and the weight of the moisture retained in the wood. Wood density varies with moisture content and must be given relative to a specific condition in order to have practical meaning. Values for density are generally based on the wood weight and volume at one of three moisture conditions: (1) oven-dry, where the moisture content is zero; (2) green, where the moisture content is greater than 30 percent; or (3) in-use, where the moisture content is specified between oven-dry and green.

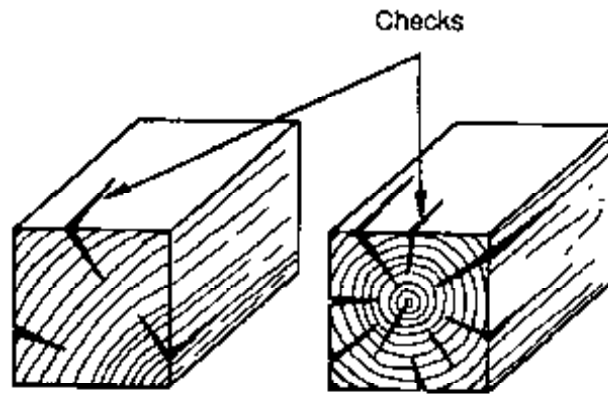

Figure 3-9.- Checks are lengthwise separations of the wood, perpendicular to the growth rings, caused by uncontrolled shrinkage in the tangential direction.

The density of oven-dry wood varies within and among species. While the density of most species is between 20 and 45 lb/ft³, the range in densities extends from approximately 10 lb/ft³ for balsa to more than 65 lb/ft³ for some imported woods. Average densities for green wood and wood at different moisture contents are given in several reference publications.^{4,30} For bridge applications, a density of 50 lb/ft³ is normally used as an average density for all species and moisture contents (Chapter 6).

SPECIFIC GRAVITY

Specific gravity provides a relative measure of the amount of wood substance contained in a sample of wood. It is a dimensionless ratio of the weight of a volume of wood at a specified moisture content to the weight of an identical volume of water at 62.4 lb/ft³. For example, a volume of wood with a specific gravity of 0.50 at some moisture content would have a density of 31.2 lb/ft³ (0.50 x 62.4 lb/ft³). In most applications, specific gravity is either reported on the basis of oven-dry weight and green volume or oven-dry weight and volume at 12 percent moisture content. For engineering purposes, specific gravity is normally based on the oven-dry weight and the volume at 12 percent moisture content.

THERMAL EXPANSION

Thermal expansion of dry wood is positive in all directions; it expands when heated and contracts when cooled. The linear expansion coefficients of dry wood parallel to grain are generally independent of species and specific gravity and range from approximately 0.0000017 to 0.0000025 per degree Fahrenheit. The expansion coefficients perpendicular to grain are proportional to density and range from five to ten times greater than parallel to grain coefficients. Wood is a good insulator and does not respond rapidly to temperature changes in the environment. Therefore, its thermal expansion and contraction lag substantially behind temperature changes in the surrounding air.

Wood that contains moisture reacts to temperature changes in a manner different from that of dry wood. In most cases, thermal expansion and contraction are negligible compared to the expansion and contraction from moisture content changes. When moist wood is heated, it tends to expand because of normal thermal expansion and to shrink because of moisture loss from increased temperature. Unless the initial moisture content of the wood is very low (3 to 4 percent), the net dimensional change on heating is negative. Wood at intermediate moisture contents of approximately 8 to 20 percent will expand when first heated, then gradually shrink to a smaller volume as moisture is lost in the heated condition. In most bridge applications, the effects of thermal expansion and contraction in wood are negligible.

COEFFICIENTS OF FRICTION

The coefficients of friction for domestic softwoods vary little among species and depend on wood moisture content and roughness of the surface. On most materials, friction coefficients for dry wood increase as moisture increases to the fiber saturation point. Above the fiber saturation point, friction coefficients remain fairly constant until considerable free water is present. When the surface is flooded with water, the coefficients of friction decrease. The sliding coefficient of friction for wood is normally less than the static coefficient and depends on the speed of sliding. Sliding coefficients vary slightly with speed when the moisture content is less than approximately 20 percent. At higher moisture contents, sliding coefficients decrease substantially as speed increases. Coefficients of sliding friction for smooth, dry wood against a hard smooth surface average from 0.3 to 0.5. At intermediate wood moisture contents, values range from 0.5 to 0.7 and increase to 0.7 to 0.9 as the moisture content nears fiber saturation. Average coefficients of friction for several conditions are given in Table 3-3.

Table 3-3.- Average coefficients of friction for wood.

Wood condition	Friction against	Average coefficient of friction	
		Static	Sliding*
Dry	Unpolished steel	0.70	0.70
Green	Unpolished steel	0.40	0.15
Dry, smooth	Dry, smooth wood	0.60	—
Green, smooth	Green, smooth wood	0.83	—

* Based on a relative movement of 13 ft/sec.

ELECTRICAL CONDUCTIVITY

Dry wood is a good electrical insulator and exhibits only minor variations in conductivity relative to variations in species and density, but significant alterations in conductivity can be related to variations in grain orientation, temperature, and moisture content. The conductivity of wood is approxi-

mately twice that for parallel to grain than for perpendicular to grain, and generally doubles for each 18 °F increase in temperature. Although electrical properties generally have little effect on bridge design, the correlation between the electrical conductivity and moisture content is the basis for electrical resistance-type moisture meters that are commonly used in bridge inspection and other activities related to product manufacturing (Chapter 13).

PYROLYTIC PROPERTIES

The pyrolytic or fire properties of wood are perhaps the most misunderstood of all wood properties. Because wood burns, it is intuitively assumed that the performance of wood under fire conditions must be poor. In fact, the heavy wood members typically used in bridges provide a fire resistance comparable to, or greater than, that of other construction materials.

When wood is exposed to fire, the exterior portions of the member may ignite. If enough energy is focused on the member, sustained, self-propagating flaming will occur. The wood beneath the flame undergoes thermal decomposition and produces combustible volatiles that sustain the flame. However, as the wood burns, a char layer is formed that helps insulate the unburned wood from engulfing flames (Figure 3-10). As the surface char layer increases, the amount of combustible volatiles released from the uncharred wood decreases, and the rate of combustion slows. The depth of the char layer under constant fire exposure increases at a rate of approximately 1- 1/2 inches per hour for Douglas-fir, but varies for other species and fire exposure conditions.

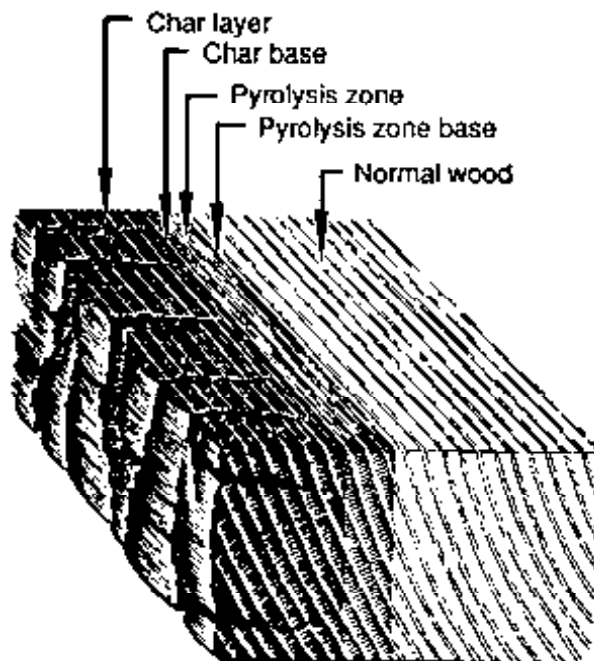

Figure 3-10.- Degradation zones in a wood section exposed to fire.

Although wood burns, its low specific gravity and thermal conductivity, combined with the insulating char layer, result in a slow rate of heat transmission into the solid, unburned wood. The surface chars, but the undamaged inner wood below the char remains at a relatively low temperature, thereby retaining its strength. As a result, the member will support loads equivalent to the capacity of the remaining uncharred section. It is this charring that allows wood to retain residual strength with surface temperatures of 1,500 °F or more. In addition, wood does not appreciably distort under high temperatures as most other materials do. When steel is subjected to elevated surface temperatures, its high mass density and thermal conductivity transport heat relatively quickly throughout the member. At temperatures of 1,500 °F, the yield strength of steel is less than 20 percent of that at room temperature.²⁶ Thus, under fire exposure, a steel member reaches its yield temperature and fails rapidly under structural load. A classic example of this scenario is shown in Figure 3-11.

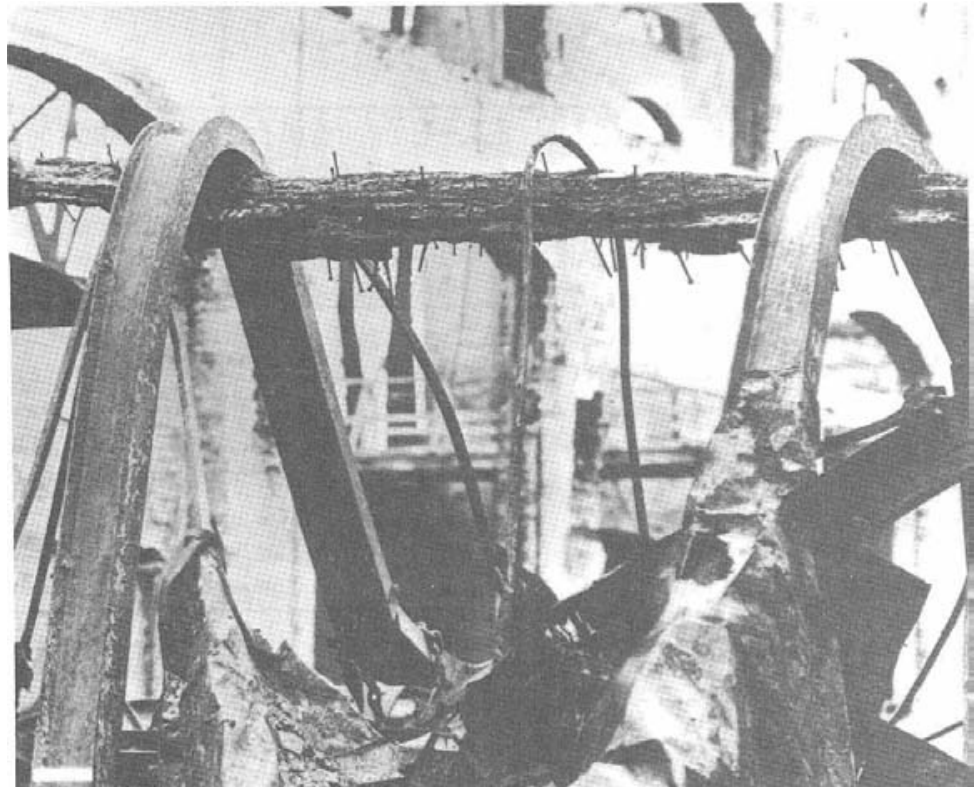

Figure 3-11.- Damage resulting from a large building fire. Steel members yielded by the heat are supported by a charred wood beam.

NATURAL DURABILITY

The natural durability of wood, or its resistance to decay and insect attack, is related to species and anatomical characteristics. In general, the sapwood of all species has little resistance to deterioration and fails rapidly in adverse environments. When heartwood is considered, natural durability

depends on species. Since the time of the Phoenicians, carpenters have known that the heartwood of some species exhibits greater durability in ground or marine environments. As discussed earlier, heartwood forms as the living sapwood cells gradually become inactive. In some species, sugars and other extraneous materials present in the cells are converted to highly toxic extractives that are deposited in the wood cell wall. In addition, some heartwoods contain internal crystalline deposits that inhibit attack by marine borers and insects. There are many species of wood in the world that provide durable heartwood, but few are found in North America. Baldcypress (old growth), cedars, and redwood are three North American commercial species that are recognized as naturally durable; however, durability varies within a tree and among species (Table 3-4). Because of this variability, it is unreliable to depend on natural durability for protection in structural applications, although many electric utilities continue to use untreated cedar poles installed in the 1930's. To ensure uniform performance, wood used in bridge applications is treated with wood preservatives that protect the structure from decay and deterioration for many years (Chapter 4).

Table 3-4.- Grouping of some domestic species according to approximate relative heartwood decay resistance.

Resistant or very resistant	Moderately resistant	Slightly or nonresistant
Baldcypress (old growth)	Baldcypress (young growth)	Hemlocks
Cedars	Douglas-fir	Pine (other than longleaf, slash, eastern white)
Redwood	Western larch	Spruces
	Eastern white pine	True firs (western and eastern)
	Longleaf pine	
	Slash pine	
	Tamarack	

From *Wood Handbook*.³⁰

CHEMICAL RESISTANCE

Wood is resistant to many chemicals. In the chemical processing industry, it is the preferred material for processing and storing chemicals that are very corrosive to other materials. In isolated cases, the presence of strong acids or bases can cause wood damage. Strong bases attack the hemicellulose and lignin, leaving the wood a bleached white color. Strong acids attack the cellulose and hemicellulose, causing weight and strength losses. Chemical resistance is normally not a concern in bridge applications with the exception of de-icing chemicals that are used in some parts of the country. Because wood is resistant to these chemicals, it has a marked advantage over more vulnerable materials, such as steel and concrete.

3.4 MECHANICAL PROPERTIES

Mechanical properties describe the characteristics of a material in response to externally applied forces. They include elastic properties, which measure resistance to deformation and distortion, and strength properties, which measure the ultimate resistance to applied loads. Mechanical properties are usually given in terms of stress (force per unit area) and strain (deformation per unit length).

The basic mechanical properties of wood are obtained from laboratory tests of small, straight-grained, clear wood samples free of natural growth characteristics that reduce strength. Although not representative of the wood typically used for construction, properties of these ideal samples are useful for two purposes. First, clear wood properties serve as a reference point for comparing the relative properties of different species. Second, they may serve as the source for deriving the allowable properties of visually graded sawn lumber used for design (Chapter 5).

ELASTIC PROPERTIES

Elastic properties relate a material's resistance to deformation under an applied stress to the ability of the material to regain its original dimensions when the stress is removed. For an ideally elastic material loaded below the proportional (elastic) limit, all deformation is recoverable, and the body returns to its original shape when the stress is removed. Wood is not ideally elastic, in that some deformation from loading is not immediately recovered when the load is removed; however, residual deformations are generally recoverable over a period of time. Although wood is technically considered a viscoelastic material, it is usually assumed to behave as an elastic material for most engineering applications, except for time-related deformations (creep), discussed later in this chapter and in Chapter 5.

For an isotropic material with equal properties in all directions, elastic properties are described by three elastic constants: modulus of elasticity (E), shear modulus (G), and Poisson's ratio (μ). Because wood is orthotropic, 12 constants are required to describe elastic behavior: 3 moduli of elasticity, 3 moduli of rigidity, and 6 Poisson's ratios. These elastic constants vary within and among species and with moisture content and specific gravity. The only constant that has been extensively derived from test data, or is required in most bridge applications, is the modulus of elasticity in the longitudinal direction. Other constants may be available from limited test data but are most frequently developed from material relationships or by regression equations that predict behavior as a function of density. General descriptions of wood elastic properties are given below with relative values for a limited number of species in Table 3-5. For additional information, refer to the references listed at the end of the chapter.^{10,30}

Table 3.5. - Elastic ratios for selected species.

Species	Modulus of elasticity (E)		Shear modulus (G)			Poisson's ratios (μ)					
	E_T/E_L	E_R/E_L	G_{LR}/E_L	G_{LT}/E_L	G_{RT}/E_L	μ_{LR}	μ_{LT}	μ_{RT}	μ_{TR}	μ_{RL}	μ_{TL}
Coast Douglas-fir ^a	.050	.068	.064	.078	.007	.29	.45	.39	.37	.04	.03
Sitka Spruce ^b	.043	.078	.064	.061	.003	.37	.47	.44	.24	.04	.02
Loblolly Pine ^c	.079	.113	.081	.081	.013	.33	.29	.38	.36	—	—
Longleaf Pine ^d	.055	.102	.071	.061	.012	.33	.37	.38	.34	—	—

^a Approximate specific gravity of 0.50 based on oven-dry weight and volume at approximately 12 percent. From *Wood Handbook*.³⁰

^b Approximate specific gravity of 0.38 based on oven-dry weight and volume at approximately 12 percent. From *Wood Handbook*.³⁰

^c Approximate specific gravity of 0.42 based on weight and volume at approximately 13 percent moisture content. From Bodig and Goodman.¹⁰

^d Approximate specific gravity of 0.46 based on weight and volume at approximately 12 percent moisture content. From Bodig and Goodman.¹⁰

Modulus of Elasticity

Modulus of elasticity relates the stress applied along one axis to the strain occurring on the same axis. The three moduli of elasticity for wood are denoted E_L , E_R , and E_T to reflect the elastic moduli in the longitudinal, radial, and tangential directions, respectively. For example, E_L , which is typically denoted without the subscript L, relates the stress in the longitudinal direction to the strain in the longitudinal direction.

Shear Modulus

Shear modulus relates shear stress to shear strain. The three shear moduli for wood are denoted G_{LR} , G_{LT} , and G_{RT} for the longitudinal-radial, longitudinal-tangential, and radial-tangential planes, respectively. For example, G_{LR} is the shear modulus based on the shear strain in the LR plane and the shear stress in the LT and RT planes.

Poisson's Ratio

Poisson's ratio relates the strain parallel to an applied stress to the accompanying strain occurring laterally. For wood, the six Poisson's ratios are denoted μ_{LR} , μ_{LT} , μ_{RT} , μ_{TR} , μ_{RL} , and μ_{TL} . The first letter of the subscript refers to the direction of applied stress, the second letter the direction of the accompanying lateral strain. For example, μ_{LR} is Poisson's ratio for stress along the longitudinal axis and strain along the radial axis.

STRENGTH PROPERTIES

Strength properties describe the ultimate resistance of a material to applied loads. They include material behavior related to compression, tension, shear, bending, torsion, and shock resistance. As with other wood properties, strength properties vary in the three primary directions, but differences between the tangential and radial directions are relatively minor and

are randomized when a tree is cut into lumber. As a result, mechanical properties are collectively described only for directions parallel to grain and perpendicular to grain, as previously discussed.

Compression

Wood can be subjected to compression parallel to grain, perpendicular to grain, or at an angle to grain (Figure 3-12). When compression is applied parallel to grain, it produces stress that deforms (shortens) the wood cells along their longitudinal axis. Recalling the straw analogy discussed in Section 3.2, each cell acts as an individual hollow column that receives lateral support from adjacent cells and from its own internal structure. At failure, large deformations occur from the internal crushing of the complex cellular structure. The average strength of green, clear wood specimens of coast Douglas-fir and loblolly pine in compression parallel to grain is approximately 3,784 and 3,511 lb/in², respectively.⁷



Compression parallel to grain tends to shorten wood cells along their longitudinal axes.

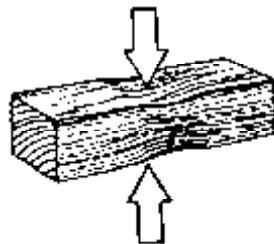

Compression perpendicular to grain compresses the wood cells perpendicular to their longitudinal axes.

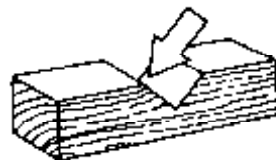

Compression at an angle to grain results in compression acting both parallel and perpendicular to grain.

Figure 3-12.- Compression in wood members.

When compression is applied perpendicular to grain, it produces stress that deforms the wood cells perpendicular to their length. Again recalling the straw analogy, wood cells collapse at relatively low stress levels when loads are applied in this direction. However, once the hollow cell cavities are collapsed, wood is quite strong in this mode because no void space

exists. Wood will actually deform to about half its initial thickness before complete cell collapse occurs, resulting in a loss in utility long before failure. For compression perpendicular to grain, failure is based on the accepted performance limit of 0.04 inch deformation. Using this convention, the average strength of green, clear wood specimens of coast Douglas-fir and loblolly pine in compression perpendicular to grain is approximately 700 and 661 lb/in², respectively.⁷

Compression applied at an angle to grain produces stress acting both parallel and perpendicular to the grain. The strength at an angle to grain is therefore intermediate to these values and is determined by a compound strength equation (the Hankinson formula) discussed in Chapter 5.

Tension

The mechanical properties for wood loaded in tension parallel to grain and for wood loaded in tension perpendicular to grain differ substantially (Figure 3-13). Parallel to its grain, wood is relatively strong in tension. Failure occurs by a complex combination of two modes, cell-to-cell slippage and cell wall failure. Slippage occurs when two adjacent cells slide past one another, while cell wall failure involves a rupture within the cell wall. In both modes, there is little or no visible deformation prior to complete failure. The average strength of green, clear wood specimens of interior-north Douglas-fir and loblolly pine in tension parallel to grain is approximately 15,600 and 11,600 lb/in², respectively.³⁰

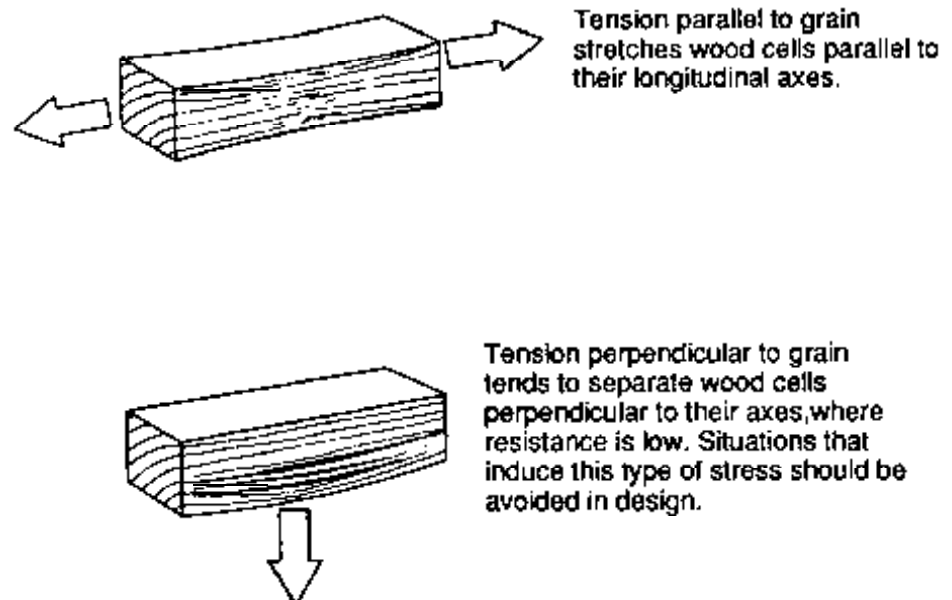
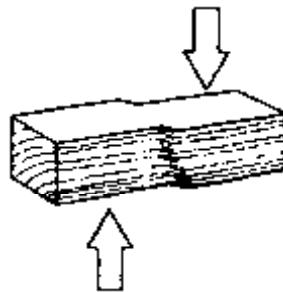

Figure 3-13.- Tension in wood members.

In contrast to tension parallel to grain, wood is very weak in tension perpendicular to grain. Stress in this direction acts perpendicular to the cell lengths and produces splitting or cleavage along the grain that significantly affects structural integrity. Deformations are usually low prior to failure because of the geometry and structure of the cell wall cross section. Strength in tension perpendicular to grain for green, clear samples of coast Douglas-fir and loblolly pine averages 300 and 260 lb/in², respectively.³⁰ However, because of the excessive variability associated with tension perpendicular to grain, situations that induce stress in this direction must be recognized and avoided in design.

Shear

There are three types of shear that act on wood: vertical, horizontal, and rolling (Figure 3-14). Vertical shear is normally not considered because other failures, such as compression perpendicular to grain, almost always occur before cell walls break in vertical shear. In most cases, the most important shear in wood is horizontal shear, acting parallel to the grain. It produces a tendency for the upper portion of the specimen to slide in relation to the lower portion by breaking intercellular bonds and deforming the wood cell structure. Horizontal shear strength for green, small clear samples of coast Douglas-fir and loblolly pine averages 904 and 863 lb/in², respectively.⁷



Vertical shear tends to deform wood cells perpendicular to their longitudinal axes. This type of shear is normally not considered for wood because other types of failures will occur before failure in vertical shear.



Horizontal shear produces a tendency for wood cells to separate and slide longitudinally. It is normally the controlling type of shear for wood members.

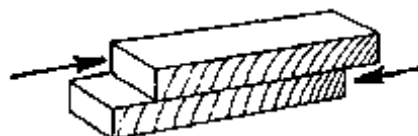

Rolling shear produces a tendency for the wood cells to roll over one another, transverse to their longitudinal axes. This type of shear is normally not a consideration for solid or laminated

Figure 3-14.- Shear in wood members.

In addition to vertical and horizontal shear, a less common type called rolling shear may also develop in wood. Rolling shear is caused by loads acting perpendicular to the cell length in a plane parallel with the grain. The stress produces a tendency for the wood cells to roll over one another. Wood has low resistance to rolling shear, and failure is usually preceded by large deformations in the cell cross sections. Test procedures for rolling shear in solid wood are of recent origin and few test values are available. In general, rolling shear strength for green, clear wood specimens average 18 to 28 percent of the shear strength parallel to grain.

Bending

When wood specimens are loaded in bending, the portion of the wood on one side of the neutral axis is stressed in tension parallel to grain, while the other side is stressed in compression parallel to grain (Figure 3-15). Bending also produces horizontal shear parallel to grain, and compression perpendicular to grain at the supports. A common failure sequence in simple bending is the formation of minute compression failures followed by the development of macroscopic compression wrinkles. This effectively results in a sectional increase in the compression zone and a sectional decrease in the tension zone, which is eventually followed by tensile failure. The ultimate bending strength of green, clear wood specimens of coast Douglas-fir and loblolly pine are reached at an average stress of 7,665 and 7,300 lb/in², respectively.⁷

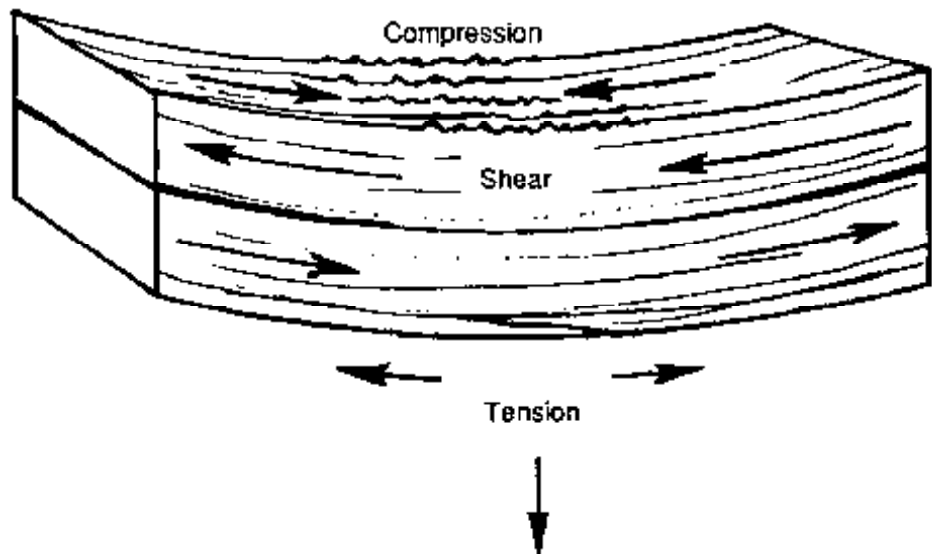

Figure 3-15.- Bending in wood members produces tension and compression in the extreme fibers, horizontal shear, and vertical deflection.

Torsion

Torsion is normally not a factor in timber bridge design, and little information is available on the mechanical properties of wood in torsion. Where needed, the torsional shear strength of solid wood is usually taken

as the shear strength parallel to grain. Two-thirds of this value is assumed as the torsional strength at the proportional limit.³⁰

Shock Resistance

Shock resistance is the ability of a material to quickly absorb, then dissipate, energy by deformation. Wood is remarkably resilient in this respect and is often a preferred material when shock loading is a consideration. Several parameters are used to describe energy absorption, depending on the eventual criteria of failure considered. Work to proportional limit, work to maximum load, and toughness (work to total failure) describe the energy absorption of wood materials at progressively more severe failure criteria.³⁰

3.5 FACTORS AFFECTING THE STRENGTH AND OTHER PROPERTIES OF WOOD

Prior to this point, discussions of wood properties have been based on small, clear, straight-grain wood without strength-reducing characteristics. Clear wood properties are important, but they by no means represent the characteristics or performance of wood products used in structural applications. Because wood is a biological material, it is subject to variations in structure or properties or both resulting from (1) anatomical factors related to growth characteristics, (2) environmental factors related to the environmental conditions where wood is used, and (3) service factors related to applied loads or chemical treatments.

ANATOMICAL FACTORS

Anatomical factors involve variations in wood structure caused primarily by natural processes or growth influences. They include specific gravity, slope of grain, knots, abnormal wood, compression failures, and shake and pitch pockets.

Specific Gravity

The strength of clear wood is generally related to the relative weight of wood per unit volume, or specific gravity. The higher the specific gravity, the more wood material per unit volume and the higher the strength. However, because specific gravity depends on the amount of water in the wood, comparisons have no practical meaning unless measured at the same moisture content. In addition, specific gravity can be misleading in some specimens because gums, resins, and extractives increase specific gravity but contribute little to mechanical properties. In general, the specific gravity of wood is directly proportional to the amount of latewood. Therefore, the higher the percentage of latewood, the higher the specific gravity and strength of the specimen.

Slope of Grain

Slope of grain or cross grain are terms used to describe the deviation in wood fiber orientation from a line parallel to the edge of the specimen (Figure 3-16). It is expressed as a ratio such as 1 in 6 or 1 in 14 and is measured over sufficient distance along the piece to be representative of the general slope of the wood fibers. Slope of grain has a significant effect on wood mechanical properties, and strength decreases as the grain deviation increases. Specimens with severe cross grain are also more susceptible to warp and other dimensional deformations because of changes in moisture content. Two common types of cross grain are spiral grain and diagonal grain (Figure 3-17).

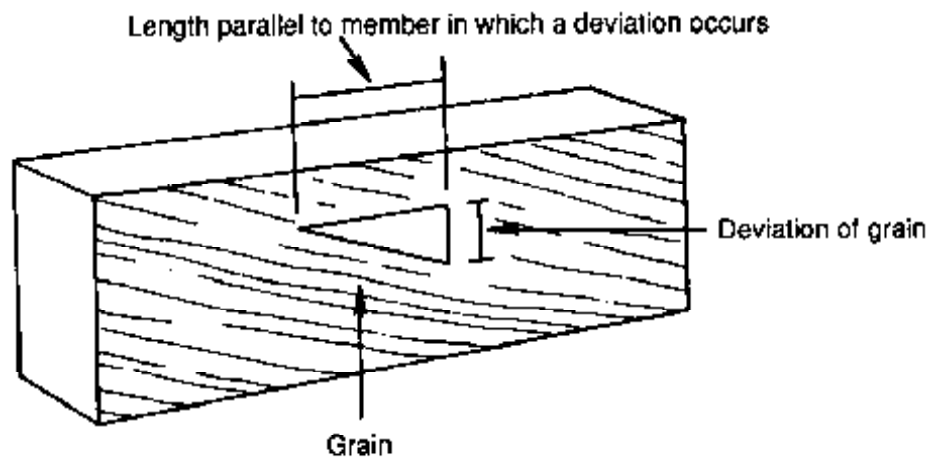

Figure 3-16.- Slope of grain measurement in wood members.

Knots

As a tree grows, buds develop and branches grow laterally from the trunk. The branches produce deviations in the normal wood growth patterns that result in two types of knots when the wood is cut, intergrown knots and encased knots (Figure 3-18). Intergrown knots are formed by living branches, while encased knots result from branches that have died and subsequently have been surrounded by the wood of the growing trunk.

Knots reduce the strength of wood because they interrupt the continuity and direction of wood fibers. They can also cause localized stress concentrations where grain patterns are abruptly altered. The influence of a knot depends on its size, location, shape, soundness, and the type of stress considered. In general, knots have a greater effect in tension than in compression, whether stresses are applied axially or as a result of bending. Intergrown knots resist some kinds of stress but encased knots or knot-holes resist little or no stress. At the same time, grain distortion is greater around an intergrown knot than around an encased knot of equivalent size. As a result, the overall effects of each are approximately the same.

Abnormal Wood

Several growth characteristics or influences can lead to the formation of abnormal wood, which differs in structure and properties from normal wood. The most important abnormal wood formations are associated with reaction wood and juvenile wood.

Reaction Wood

Reaction wood is abnormal wood produced by a tree in response to irregular environmental or physical stresses associated with a leaning trunk

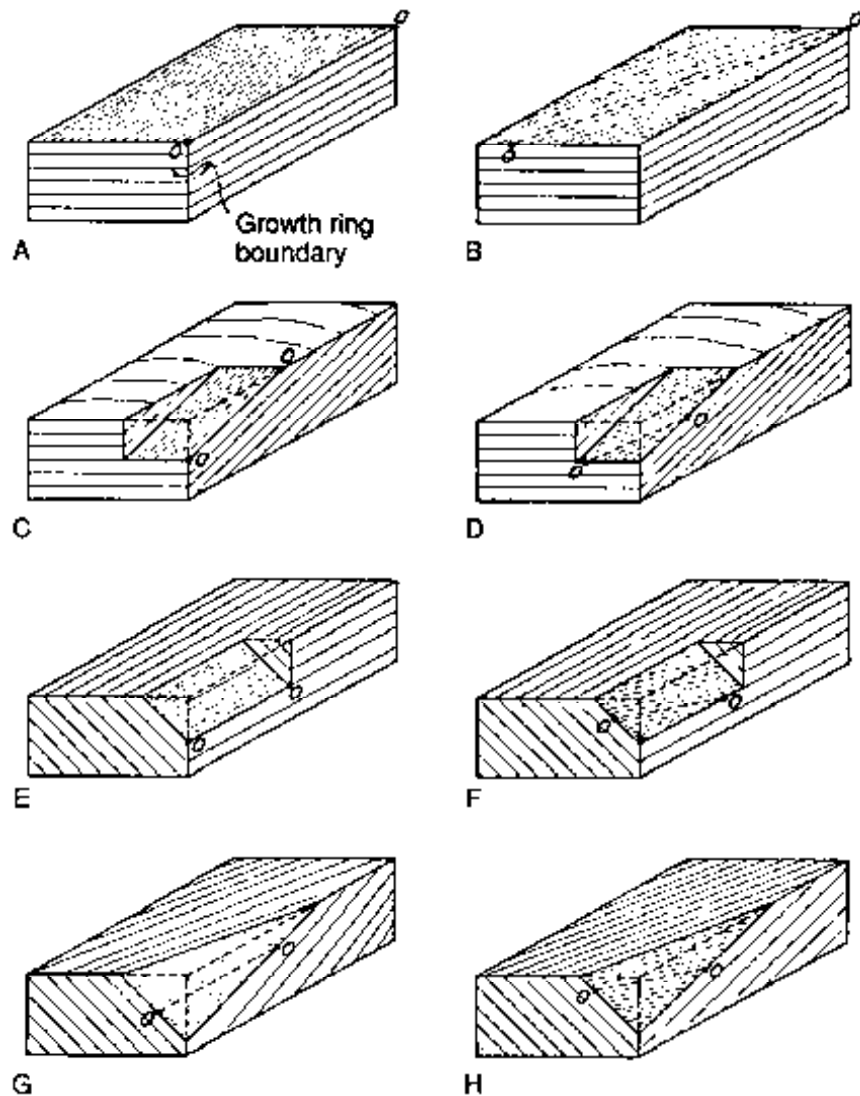

Figure 3-17- Schematic views of wood specimens containing straight grain and cross grain to illustrate the relationship of fiber orientation (O-O) to the axes of the piece. Specimens A through D have radial and tangential surfaces; E through H do not. A through E contain no cross grain. B, D, F, and H have spiral grain. C, D, G, and H have diagonal grain.

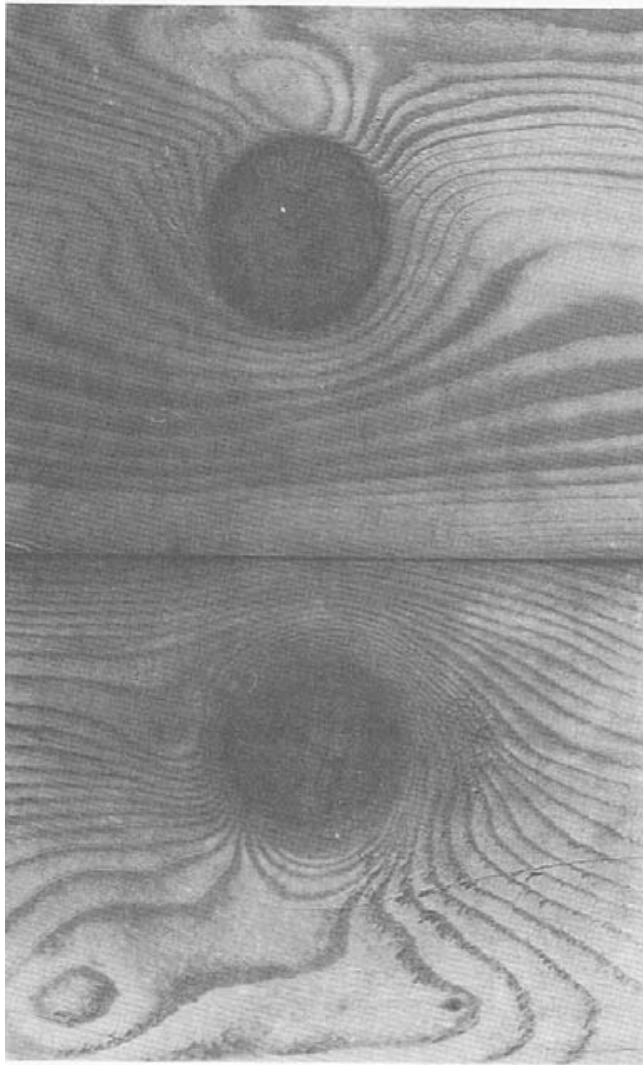

Figure 3-18.- Types of knots. (Top) encased knot and (bottom) intergrown knot.

and crooked limbs. Its growth is generally believed to be a response by the tree to return the trunk or limbs to a more natural position. In softwoods, reaction wood is called compression wood and is found on the lower side of a leaning tree or limb (Figure 3-19). It is denser and generally weaker than normal wood and exhibits significant differences in anatomical, physical, and mechanical properties. The specific gravity of compression wood is frequently 30 to 40 percent greater than normal wood, but when compared to normal wood of comparable specific gravity, compression wood is weaker. Compression wood also exhibits abnormal shrinkage characteristics from moisture loss, with longitudinal shrinkage up to 10 times that of normal wood.

Juvenile Wood

Wood cells produced by a tree in the first years of growth exhibit variations in wood cell structure distinct from cell structure in wood that develops in later years. This wood, known as juvenile wood, has lower

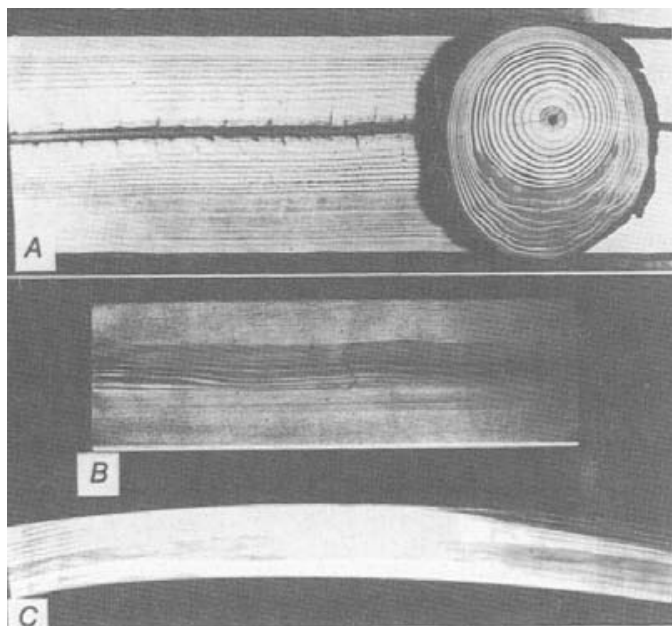

Figure 3-19.-*(A) Eccentric growth about the pith in a cross section containing compression wood. The dark area in the lower third of the cross section is compression wood. (B) Axial tension break caused by excessive longitudinal shrinkage of compression wood. (C) Warp caused by excessive longitudinal shrinkage of compression wood.*

strength properties and an increased susceptibility to warpage and longitudinal shrinkage. The duration of juvenile wood production varies for species and site conditions from approximately 5 to 20 years. In large-diameter, old-growth trees, the proportion of juvenile wood is small, and its effects in structural applications have been negligible. However, juvenile wood has recently become a more prevalent consideration within the wood industry because of the trend toward processing younger, smaller diameter trees as the large-diameter, old-growth trees become difficult to obtain.

Compression Failures

Extreme bending in trees from environmental conditions or mishandling during or after harvest can produce excessive compression stress parallel to grain that results in minute compression failures of the wood structure. In some cases, these failures are visible on the wood surface as minute lines or zones formed by the crumpling or buckling of the cells (Figure 3-20 A). They may also be indicated by fiber breakage on the end grain (Figure 3-20 B). Compression failures can result in low shock resistance and strength properties, especially in tension where strength may be less than one-third that of clear wood. Even slight compression failures, visible only with the aid of a microscope, can seriously reduce strength and cause brittle fractures.

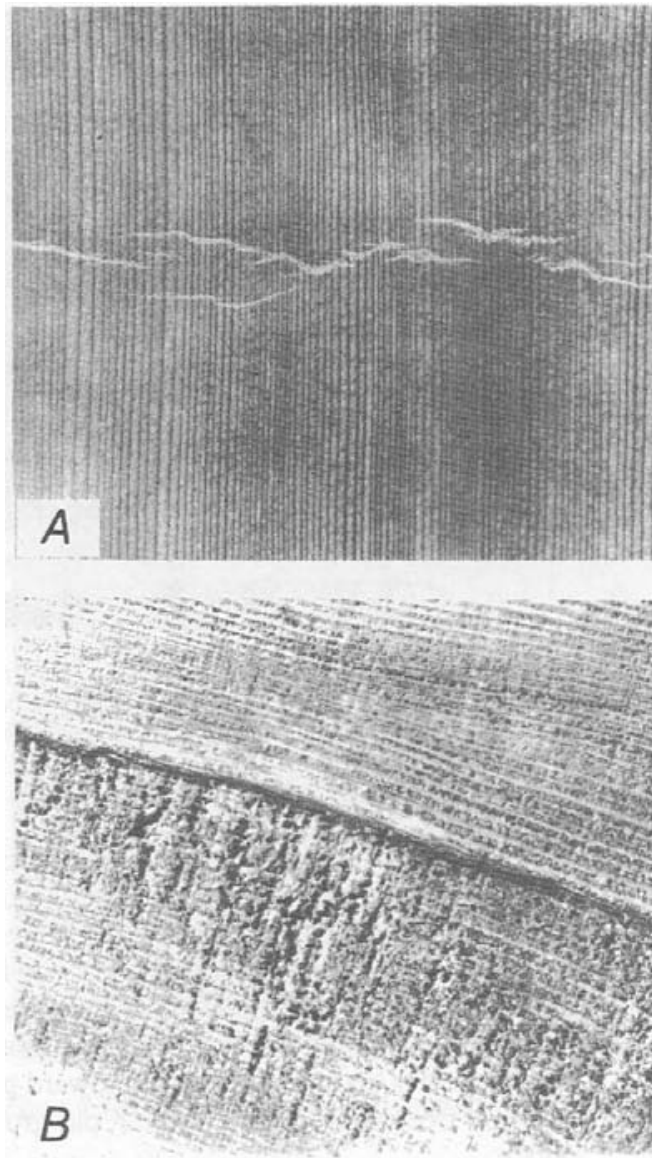
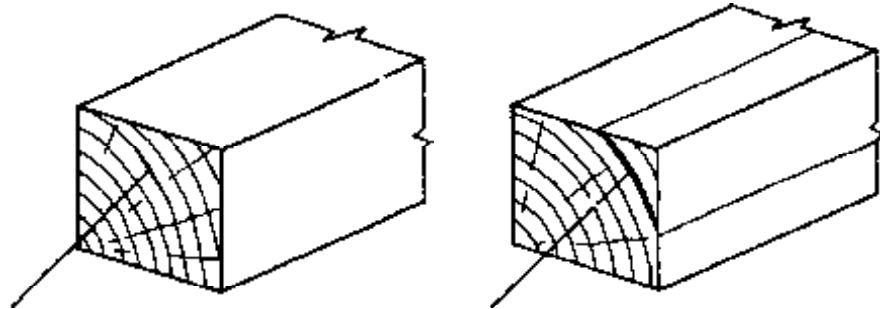

Figure 3-20.--(A) Compression failure is shown by irregular lines across the grain. (B) End-grain surface showing fiber breakage caused by compression failures below the dark line.

Shake and Pitch Pockets

Two natural characteristics in wood structure that can affect strength are shake and pitch pockets (Figure 3-21). A shake is a separation or plane of weakness between two adjacent growth increments. It is thought to occur because of excessive stresses imposed on the standing tree, or during harvest, and can extend a substantial distance in the longitudinal direction. Pitch pockets are well-defined openings that contain free resin. They extend parallel to the annual growth rings and are usually flat on the pith side and curved on the bark side. Pitch pockets are normally localized and do not extend far in the longitudinal direction. In bending specimens, shakes can severely reduce shear strength but usually have little effect on

specimens subjected only to tension or compression. Pitch pockets generally have no significant effect on strength, but a large number of pitch pockets may indicate the presence of shake and a lack of bond between annual growth layers, which may result in some strength loss, particularly in shear.



A pitch pocket is a well-defined opening that contains free resin. Pitch pockets are usually localized and do not extend far in the longitudinal direction.

A shake is a separation or plane of weakness between growth increments that may extend a substantial distance in the longitudinal direction.

Figure 3-21.-Drawing of a pitch pocket and a shake.

ENVIRONMENTAL FACTORS

Environmental factors are related to the effects of the surroundings on the performance and properties of wood. They include moisture content, temperature, decay and insect damage, and ultraviolet degradation.

Moisture Content

The strength and stiffness of wood are related to moisture content between the oven-dry condition and the fiber saturation point.¹⁷ When clear wood is dried below the fiber saturation point, strength and stiffness increase. When clear wood absorbs moisture below the fiber saturation point, strength and stiffness decrease. Wood properties in both directions are recoverable to their original values when the moisture content is restored. The approximate middle-trend effects of moisture content on the mechanical properties of clear wood are shown in Table 3-6.

When wood contains strength-reducing characteristics (primarily knots), wood properties are currently assumed to be linearly related to moisture content for specimens up to 4 inches thick. However, recent research indicates that the effects of moisture content are not linear.²⁰ In wood with small strength-reducing characteristics, properties increase linearly with decreasing moisture content. In wood with large strength-reducing characteristics, however, there may be no increase in strength as the wood dries because the potential strength increases are offset by losses from shrinkage and seasoning defects. Although these effects have not yet been recog-

Table 3-6.- Approximate middle-trend effects of moisture content on the mechanical properties of clear wood at about 68 °F.

Property	Relative change in property from 12% moisture content	
	At 6% moisture content	At 20% moisture content
Modulus of elasticity parallel to grain	+9	-13
Modulus of elasticity perpendicular to grain	+20	-23
Shear modulus	+20	-20
Bending strength	+30	-25
Tensile strength parallel to grain	+8	-15
Compressive strength parallel to grain	+35	-35
Shear strength parallel to grain	+18	-18
Tensile strength perpendicular to grain	+12	-20
Compressive strength perpendicular to grain at proportional limit	+30	-30

From *Wood Handbook*.³⁰

nized in existing codes and standards, it is likely that they will be incorporated in the near future.

Temperature

In general, the mechanical properties of wood decrease when it is heated and increase when it is cooled. This temperature effect is immediate and, for the most part, recoverable for short heating durations as long as wood is not exposed to temperatures higher than 150 °F for extended periods. A permanent reduction in strength results from degradation of the wood substance if exposure to temperatures higher than 150 °F occurs. The magnitude of these permanent effects depends on the moisture content, heating medium, temperature, exposure time, and, to a lesser extent, species and specimen size.^{17,22} In most cases, temperature is not a factor in bridge design (Chapter 5).

Decay and Insect Damage

Under certain conditions, wood may be subject to deterioration from decay or insect damage. Decay effects on strength can be many times greater than visual observation indicates, with possible strength losses of 50 to 70 percent for a corresponding weight loss of only 3 percent. Insects that use wood as food or shelter can also remove a substantial portion of the wood structure and severely alter strength and other properties. Fortunately, wood preservatives have been developed that protect wood from decay and insect attack (Chapter 4). Additional discussions on the agents of wood deterioration and decay effects on strength are in Chapter 13.

Ultraviolet Degradation

Wood exposed to ultraviolet radiation in sunlight undergoes chemical reactions that cause photochemical degradation, primarily in the lignin component. This produces a characteristic grayish wood color in a process commonly known as weathering (Figure 3-22). As the wood surface degrades, cells erode and new wood cells are exposed, continuing the process. However, because this degradation is very slow, occurring at an estimated rate of only 1/4 inch per century, its impact is mainly one of aesthetics without serious effects on mechanical properties. Most wood preservative treatments (except waterborne preservatives discussed in Chapter 4) and opaque and semitransparent finishes inhibit weathering, which is normally not a concern in structural applications.

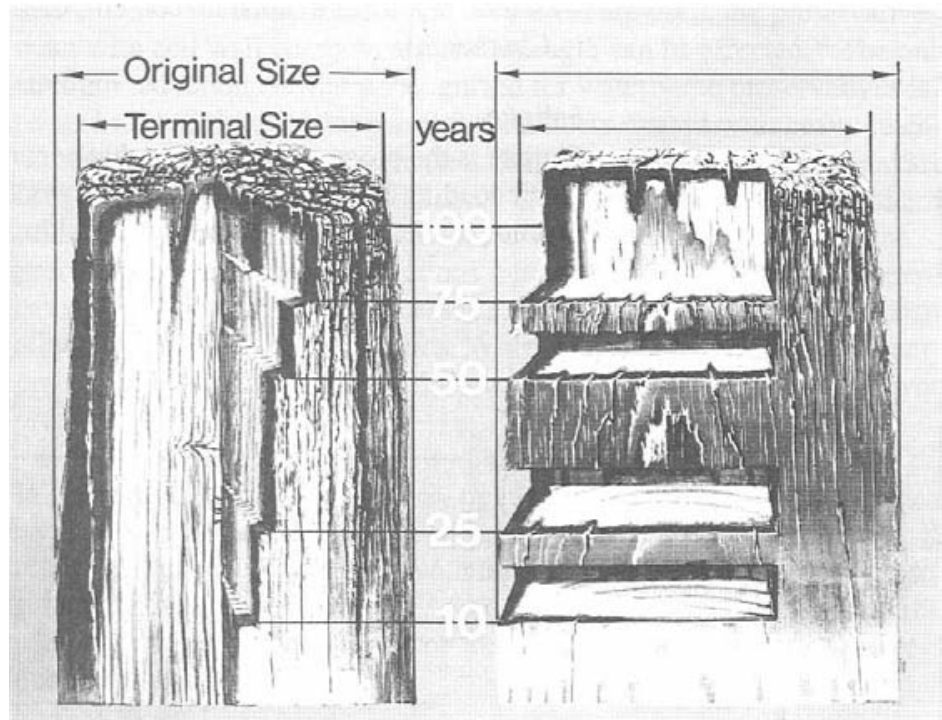

Figure 3-22.- Artist's rendition showing the weathering process of round and square timbers. Cutaway shows that interior wood below the surface is relatively unchanged.

SERVICE FACTORS

Service factors are related to the loading and chemical treatment of wood. They include duration of load, creep, fatigue, and treatment factors.

Duration of Load

Wood exhibits the unique property of carrying substantially greater maximum loads for short durations than for long periods. The shorter the duration of load, the higher the ultimate strength of the wood. Long-term tests have also shown that a series of intermittent loads produces the same cumulative effects on strength as a continuous load of equivalent duration.¹⁸ For example, a load applied for alternating years over a 50-year

period would have the same effect as the same load applied continuously for 25 years. For structural applications, wood strength values are based on an assumed normal load duration of 10 years (Chapter 5). Based on this assumption, the relationship of strength to duration of load is shown in Figure 3-23.

Creep

Duration of load affects the deformation of wood specimens subject to bending. For loads of relatively short duration, wood deflects elastically and essentially recovers its original position when the load is removed. Under sustained loading, however, wood exhibits an additional time-dependent deformation known as creep, which is not recoverable when the load is removed. Creep develops at a slow but persistent rate that increases with temperature and moisture content. Creep is discussed in more detail in Chapter 5.

Fatigue

Fatigue is the progressive damage that occurs in a material subjected to cyclic loading. The fibrous structure of wood is resistant to fatigue failure. At comparable stress levels relative to ultimate strength, the fatigue

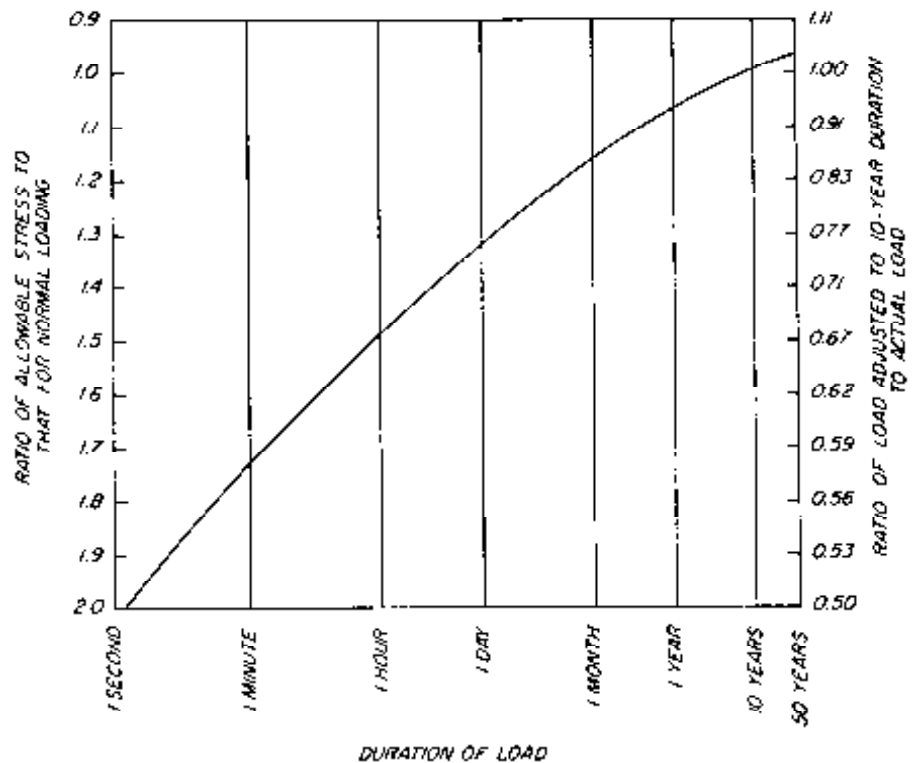

Figure 3-23.- Duration of load adjustment curve for wood.

strength of wood is often several times that of most metals.^{21,30} The potential for fatigue-related failures in wood is generally considered to be minor, provided the stress cycles in bending do not exceed the proportional limit in bending. Fatigue is not normally a consideration in bridge design.

Treatment Factors

During the manufacturing process, wood may be treated with preservatives or fire-retardant chemicals to improve its performance and longevity in adverse environments (Chapter 4). Applied chemicals or treatment processes can affect the properties of wood in some situations. When wood preservatives are considered, oil-type preservatives do not react with the cell wall components, and no appreciable strength loss from the chemicals occurs.⁹ When waterborne preservatives are used, the preservatives do react with cell wall components, and strength can be affected.³⁷ The only strength reduction currently recognized for waterborne preservatives is related to load duration increases for members treated with heavy retentions required for saltwater use (see Chapters 4 and 5); however, research is in progress to investigate additional effects of some waterborne chemicals on wood strength and ductility. For both oil-type and waterborne preservatives, significant reductions in strength and other wood properties can occur when treatment processes exceed the temperatures or pressures allowed by treating specifications. When proper preservative treatment procedures and limitations are followed, no significant alteration in wood properties is found.

In contrast to wood preservatives, treatment with fire-retardant chemicals can have a marked effect on wood strength and other properties. With fire retardants, the chemicals react with the cell wall components and cause substantial strength reductions.³⁷ As a general rule, fire retardants are not used in bridge applications. When they are, strength values must be reduced accordingly (Chapter 5).

3.6 PROPERTIES OF SAWN LUMBER

Square or rectangular lengths of wood that are cut from logs are called sawn lumber. Sawn lumber is the product of a sawmill and planing mill and is usually not manufactured beyond sawing, resawing, passing lengthwise through a standard planing machine, crosscutting to length, and matching. Sawn lumber is the most widely used of all timber products and is a primary material for timber bridge construction. Millions of board feet of lumber are produced each year from sawmills located in all parts of the United States.

As lumber is cut from a log, its quality and properties vary. To enable users to purchase the material that suits their particular purposes, sawn

lumber is graded into categories of quality or appearance or both. Generally, the grade of a piece of lumber is based on the number and type of features that may lower the strength, durability, or utility of the lumber. Sawn lumber categories and grades are intended for a variety of purposes. For bridges and many other structural uses, sawn lumber categorized as stress-graded structural lumber is used almost exclusively. Structural lumber is graded primarily to provide design values in strength and stiffness. Further discussions in this section are limited to structural lumber only.

PRODUCT STANDARDS

Prior to the early 1900's, the manufacture and grading of sawn lumber was comparatively simple because most sawmills marketed their lumber locally, and grades had only local significance. As new timber sources were developed and lumber was transported to distant points, the need for some degree of standardization in lumber size, grade characteristics, and grade names became necessary. The U.S. Department of Commerce, in cooperation with lumber producers, distributors, and users, formulated a voluntary American Softwood Lumber Standard. The current version of that standard is the American Softwood Lumber Standard PS 20-70 (ALS).³¹ The ALS serves as the basic product standard for structural lumber produced in the United States. When lumber conforms to the basic size, grading, labeling, and inspection provisions of the ALS, it may be designated as *American Standard Lumber*.

The objective of the ALS is to provide a reliable level of product standardization, yet allow enough flexibility for more specialized products on a regional basis. To accomplish this with structural lumber, the ALS provides for a National Grading Rule (NGR). The ALS and the NGR prescribe the ways in which stress-grading principles can be used to formulate grading rules said to be American Standard. Specifically, they contain information and standards related to lumber sizes, grade names, and grade descriptions. A grade description denotes the maximum number and location of strength-reducing characteristics that are allowed in a particular grade of lumber, and places limitations on other non-strength-reducing characteristics. All American Standard Lumber that is less than 5 inches thick must conform to the NGR and its requirements for standard sizes, grade names, and grade descriptions. For lumber that is 5 inches or more in thickness, the ALS specifies standard sizes, but grade names and grade descriptions are written, published, and certified by independent industry groups called grading rules agencies. Although grade names and descriptions for these lumber grades basically follow the NGR, there are minor differences among different grading rules agencies. Grade names and descriptions written by the grading rules agencies must be certified by the American Lumber Standards Committee before they can be considered as American Standard Lumber. A listing of the United States agencies that are currently certified to write grading rules is given in Table 3-7.

LUMBER MANUFACTURE

Lumber production starts when merchantable timber is felled, limbed, cut into logs, and transported to a sawmill for conversion into lumber. At the sawmill, the first step in lumber manufacture is generally log debarking, after which the logs are sawn into lumber (Figure 3-24). Softwood lumber can be cut from a log in two ways: tangent to the growth rings to produce flat-grain lumber or radially to the rings to produce edge-grain lumber. In commercial practice, most lumber falls somewhere in between, and lumber with rings at angles of 45 to 90 degrees to the wide face is considered edge-grain lumber, while lumber with rings at angles less than 45 degrees to the wide face is considered flat-grain lumber (Table 3-8). After cutting, lumber can be surfaced (planed) and shipped green, or dried and surfaced later. Most lumber 2 inches thick or less is either air-dried or kiln-dried before it is surfaced. For larger lumber sizes, it is impractical to dry the lumber, and it is generally shipped green.

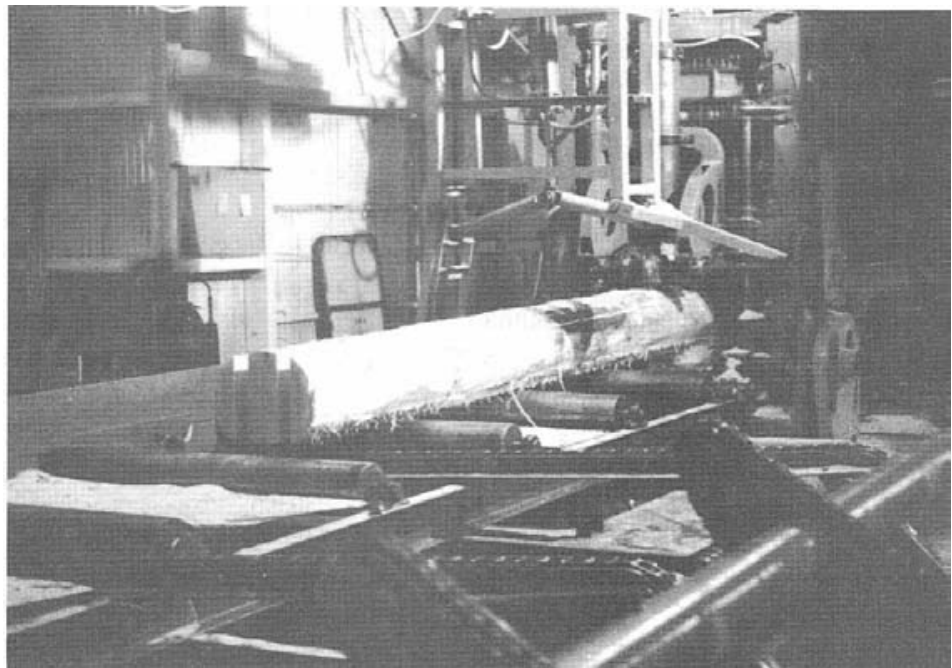

Figure 3-24.-A log being sawn into lumber at a modern sawmill (photo courtesy of Frank Lumber Co.).

Lumber Species

Lumber is manufactured from a great variety of species. The commercial names of these species may vary from the official tree names adopted by the USDA Forest Service. In addition, some species with approximately the same mechanical properties are marketed together in species groups. The commercial designation Southern Pine, for example, is actually a species group comprised of loblolly pine, shortleaf pine, longleaf pine, slash pine, and others. Standard lumber names adopted by the ALS are shown in Table 3-9. Information regarding species and species groups not

Table 3-7.- U.S. grading rules agencies certified to write grading rules.

Agency	Lumber type
Northeastern Lumber Manufacturers Association (NELMA) 272 Tuttle Road P.O. Box 87A Cumberland Center, ME 04021	Aspen, balsam fir, beech, birch, eastern hemlock, eastern white pine, red pine, black spruce, white spruce, red spruce, pitch pine, tamarack, jack pine, northern white cedar, hickory, maple, red oak, white oak
Northern Hardwood and Pine Manufacturers Association (serviced by NELMA) 272 Tuttle Road P.O. Box 87A Cumberland Center, ME 04021	Aspen, cottonwood, balsam fir, eastern white pine, red pine, eastern hemlock, black spruce, white spruce, red spruce, pitch pine, tamarack, jack pine, yellow poplar
Redwood Inspection Service (RIS) 591 Redwood Highway, Suite 3100 Mill Valley, CA 94941	Redwood
Southern Pine Inspection Bureau (SPIB) 4709 Scenic Highway Pensacola, FL 32504	Longleaf pine, slash pine, shortleaf pine, loblolly pine, Virginia pine, pond pine, pitch pine
West Coast Lumber Inspection Bureau (WCLIB) Box 23145 6980 SW. Varns Road Portland, OR 97223	Douglas-fir, western hemlock, western redcedar, incense-cedar, Port-Orford-cedar, Alaska-cedar, western true firs, mountain hemlock, Sitka spruce
Western Wood Products Association (WWPA) 1500 Yeon Building Portland, OR 97204	Ponderosa pine, western white pine, Douglas-fir, sugar pine, western true firs, western larch, Engelmann spruce, incense-cedar, western hemlock, lodgepole pine, western redcedar, mountain hemlock, red alder, aspen

From Wood Handbook.³⁰

listed in this table should be obtained from the appropriate grading rules organizations (Table 3-7).

Lumber Sizes

Structural lumber is manufactured in many sizes depending on use requirements. Lengthwise, it is normally produced in even, 2-foot increments. In width and thickness, common sizes vary from 2 to 16 inches,

Table 3-8.- Some relative advantages of flat-grain and edge-grain lumber.

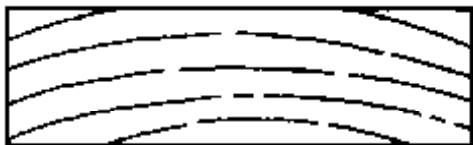

Flat-grain plank; rings form an angle less than 45° with the wide surface.



Edge-grain plank; rings form an angle of 45° to 90° with the wide surface.

Round or oval knots that may occur in flat-grain lumber affect the surface appearance less than spike knots that may occur in edge-grain lumber. Also, lumber with a round or oval knot is not as weak as lumber with a spike knot. seasoning and in use.

Shakes and pitch pockets, when present, extend through fewer pieces from the same log.

It is less susceptible to collapse in drying.

It shrinks and swells less in thickness.

It may cost less because it is generally easier to obtain.

Edge-grain lumber shrinks and swells less in width.

It twists and cups less.

It surface-checks and splits less in

It wears more evenly.

It does not allow liquids to pass into or through it so readily in some species.

The sapwood appearing in lumber is at the edges and its width is limited according to the width of the sapwood in the log.

From Wood Handbook.³⁰

although larger sizes are obtainable for some species. Because available lumber sizes vary with species and locations, it is advisable to confirm size availability with local suppliers.

Lumber Size Classifications

During the evolution of stress grading in the United States, lumber size served as a guide in anticipating the final use of the piece. As a result, lumber came to be categorized into size classifications based on thickness and width. The three size classifications for structural lumber are Dimension Lumber, Beams and Stringers, and Posts and Timbers (Table 3-10).

Table 3-9.- Nomenclature of commercial softwood lumber.

Standard lumber names under ALS ³¹	Official Forest Service tree name	Standard lumber names under ALS ³¹	Official Forest Service tree name
Cedar		Pine	
Alaska	Alaska-cedar	Idaho white	Western white pine
Eastern red	Eastern redcedar	Jack	Jack pine
Incense	Incense-cedar	Lodgepole	Lodgepole pine
Northern white	Northern white-cedar	Longleaf yellow"	Longleaf pine
Port Orford	Port-Orford-cedar		Slash pine
Southern white	Atlantic white-cedar	Northern white	Eastern white pine
Western red	Western redcedar	Norway	Red pine
Cypress		Ponderosa	Ponderosa pine
Red (coast type), yellow (inland type), white (inland type)	Baldcypress	Southern (Major)	Longleaf pine
Douglas-fir	Douglas-fir		Shortleaf pine
Fir		Southern (Minor)	Loblolly pine
Balsam	Balsam fir		Slash pine
	Fraser fir		Pitch pine
Noble	Noble fir		Pond pine
White	California red fir		Sand pine
	Grand fir	Sugar	Table mountain pine
	Pacific silver fir	Redwood	Virginia pine
	Subalpine fir	Spruce	Sugar pine
	White fir	Eastern	Redwood
Hemlock			Black spruce
Eastern	Eastern hemlock		Red spruce
Mountain	Mountain hemlock	Engelmann	White spruce
West Coast	Western hemlock		Blue spruce
Juniper, western	Alligator juniper	Sitka	Engelmann spruce
	Rocky Mountain juniper	Tamarack	Sitka spruce
	Utah juniper	Yew, Pacific	Tamarack
	Western juniper		Pacific Yew
Larch, western	Western larch		

³¹The commercial requirements for longleaf pine are that it be produced from the species *Pinus elliotii* and *P. palustris* and that each piece must average either on one end or the other not less than 6 annual rings per inch and not less than 1/3 latewood. Longleaf pine lumber is sometimes designated as pitch pine in the export trade.

From Wood Handbook³⁰

Table 3-10.- Lumber size classifications.

Name	Symbol	Nominal dimensions		Typical sizes
		Thickness	Width	
Dimension Lumber				
Light Framing	LF	2 to 4 in.	2 to 4 in.	2x4, 4x4
Joist and Plank	J&P	2 to 4 in.	5 in. and wider	2x6, 2x12, 4x12, 4x16
Decking ^a	-	2 to 4 in.	4 in. and wider	2x6, 2x10 4x10, 4x12
Beams and Stringers	B&S	5 in. and thicker	More than 2 in. greater than thickness	6x10, 6x14 8x16, 10x18
Posts and Timbers	P&T	5 in. and thicker	Not more than 2 in. greater than thickness	6X6, 10X12 10x10, 12x14

^aDecking sizes are the same as those designated for Light Framing and Joist and Plank. Decking is intended for flatwise use while LF and J&P are intended for edgewise use.

1. **Dimension Lumber** is lumber that is 2 to 4 inches thick and 2 or more inches wide. This classification is further divided into a number of subcategories, the most common of which are Light Framing (LF), Joists and Planks (J&P), and Decking. LF and J&P are graded primarily for edgewise loading, while Decking is graded primarily for use in the flatwise orientation.
2. **Beams and Stringers (B&S)** are rectangular pieces that are 5 or more inches thick, with a width more than 2 inches greater than the thickness. B&S are graded primarily for use as beams, with loads applied to the narrow face.
3. **Posts and Timbers (P&T)** are pieces with a square or nearly square cross section, 5 by 5 inches and larger, with the width not more than 2 inches greater than the thickness. Lumber in the P&T size classification is graded primarily for resisting axial loads where strength in bending is not especially important.

An important point to understand about lumber size classifications is that they are based on the most efficient *anticipated* use of the member, rather than the actual use. The classifications are relevant to grading, which will be discussed later, but there are no restrictions on actual use for any size classification, provided the design stresses are within the stresses allowed for the grade.

Lumber Dimensions

Lumber dimensions for thickness and width, including those for defining size classifications, are traditionally recorded in nominal dimensions. These dimensions are usually in 2-inch increments such as 2 by 4 or 8 by 12. The nominal dimensions are normally greater than the actual net dimensions of the piece. In timber design, structural calculations must be based on the net lumber dimensions for the anticipated use conditions. These net dimensions depend on the type of surfacing, whether dressed, rough-sawn, or full-sawn (Figure 3-25).

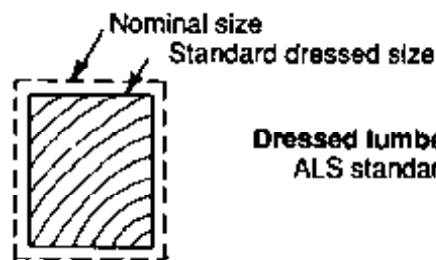

Dressed lumber is smaller than the stated nominal size.
ALS standard dressed sizes are shown in Table 3-11.

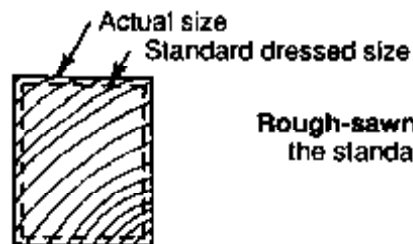

Rough-sawn lumber is approximately 1/8" larger than the standard dressed size.

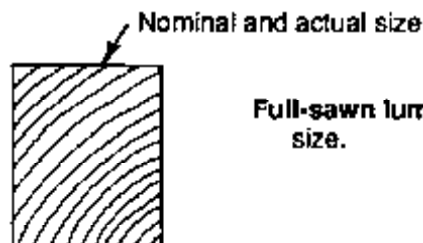

Full-sawn lumber is the same size as the stated nominal size.

Figure 3-25.- Dressed, rough-sawn, and full-sawn lumber sizes.

Dressed lumber is surfaced on all four sides (S4S) at the time of manufacture to a minimum net dimension that is standardized by the ALS (Table 3-11). Lumber in the B&S and P&T size classifications, collectively referred to as Timbers, are normally surfaced green, and only green sizes are specified by the ALS. Dimension lumber may be surfaced green or dry at the prerogative of the manufacturer; therefore, both green and dry standard sizes are given. The green sizes are slightly larger in anticipation that the piece, as it dries, will shrink to the standard dry size. The ALS definition of dry lumber is lumber with a moisture content of 19 percent or less. For design purposes, the minimum dry dressed dimensions are used

for structural calculations regardless of the moisture content at the time of manufacture or in use. For example, section properties for a standard dressed 2 by 6 are based on a section 1-1/2 inches by 5-1/2 inches, while for a standard 8 by 12, dimensions are 7-1/2 inches by 11-1/2 inches. Tables of section properties for standard dressed lumber are given in Chapter 16.

Table 3-11.- American Standard Lumber sizes for structural lumber.

Size classification	Thickness (in.)			Face width (in.)		
	Nominal dimension	Minimum dressed dimension		Nominal dimension	Minimum dressed dimension	
		dry	green		dry	green
Dimension Lumber	2	1-1/2	1-9/16	2	1-1/2	1-9/16
	2-1/2	2	2-1/16	3	2-1/2	2-9/16
	3	2-1/2	2-9/16	4	3-1/2	3-9/16
	3-1/2	3	3-1/16	5	4-1/2	4-5/8
	4	3-1/2	3-9/16	6	5-1/2	5-5/8
	4-1/2	4	4-1/16	8	7-1/4	7-1/2
				10	9-1/4	9-1/2
				12	11-1/4	11-1/2
				14	13-1/4	13-1/2
				16	15-1/4	15-1/2
Beams and Stringers and Posts and Timbers	5 and greater		1/2 less than nominal	5 and greater		1/2 less than nominal

From *Wood Handbook*.³⁰

Rough-sawn lumber is normally about 1/8 inch larger than standard dry dressed sizes. Full-sawn lumber, which is not widely used, is cut to the same dimensions as the nominal size. In both cases, thickness and width dimensions are variable depending on the sawmill equipment. It is impractical to use rough-sawn or full-sawn lumber in a structure that requires close dimensional tolerances. For more accurate dimensions, surfacing can be specified on one side (S1S), two sides (S2S), one edge (S1E), two edges (S2E), combinations of sides and edges (S1S1E, S2S1E, S1S2E), or all sides (S4S). When designing with either rough-sawn or full-sawn lumber, the applicable moisture content and dimensions used in design must be clearly noted on the plans and material specifications.

LUMBER GRADING

When lumber is cut from a log, the properties of the individual pieces vary considerably in strength and stiffness. To have practical use in engineering

applications, the lumber must be graded into categories for which reliable engineering properties can be assigned. Stress grades for lumber are characterized by one or more sorting criteria, a set of engineering properties, and a unique grade name. For each species or species group in each grade and size classification, the information related to sorting criteria and design values is contained in the grade description. Based on the information in the grade description, values for structural lumber are established for the following:

1. Modulus of elasticity
2. Tensile stress parallel to grain
3. Compressive stress parallel to grain
4. Compressive stress perpendicular to grain
5. Shear stress parallel to grain (horizontal shear)
6. Bending stress

Lumber grading is accomplished using visual grading criteria or non-destructive measurement using mechanical grading equipment. Grading for most lumber takes place at the sawmill. Generally, the grade of a piece of lumber is based on the number, character, and location of features that lower the strength, stiffness, or durability of the piece. Among the more common features that are evaluated during grading are knots and slope of grain, but many potential strength-reducing characteristics are considered.

Visual Stress Grading

Visual stress grading is the oldest and most widely used lumber grading method. It is based on the premise that the mechanical properties of lumber differ from those of clear wood because of growth characteristics that can be judged by the eye. After the lumber is sawn and surfaced (when required), each piece is examined by a lumber grader who is certified by one of the grading agencies (Figure 3-26). If the piece of lumber meets the grade description requirements for a particular grade, it is assigned that grade and the associated mechanical properties. If the piece does not meet requirements for one grade, it may qualify for a lower grade, or be rejected.

As previously discussed, all grades for dimension lumber are standardized by the NGR. However, grade names and descriptions for lumber in the B&S and P&T size classifications are not standardized and may vary among different grading rules agencies. There are many visual grades of structural lumber for the species groups and size classifications. Some of the typical grade names for Douglas Fir-Larch are shown in Table 3-12.

The engineer need not have an in-depth knowledge of all grade descriptions and the specifics of how they are derived. If a piece of lumber is graded, the tabulated values for that grade (discussed in Chapter 5) can be used for structural computations. It is beneficial, however, to have a basic understanding of how various grade requirements and tabulated design values are derived to better understand wood as an engineering material.



Figure 3-26.- Sawn lumber being visually graded and marked at a sawmill (photo courtesy of Funk Lumber Co.).

The process of establishing design properties for visually graded lumber is addressed in detail in ASTM D 245, Standard Methods for Establishing Structural Grades and Related Allowable Properties for Visually Graded Lumber.⁶ A brief summary of the process is as follows:

1. The mechanical properties for each lumber grade may be established by adjusting test results conducted on small, clear green wood specimens of the species or species group (small, clear procedure), or by testing a representative sample of full-size members (in-grade procedure). The mechanical properties of virtually all lumber currently used in the United States have been derived using the small, clear procedure outlined in ASTM D 2555, Standard Methods for Establishing Clear Wood Strength Values.⁷ A comprehensive re-evaluation based on in-grade testing is currently in progress, and it is anticipated that mechanical properties will be based on test results from full-size specimens in the next few years.¹⁹

Based on the small, clear procedures, large numbers of clear wood specimens are tested for each species or species group to determine ultimate stress and stiffness values. These values then serve as the starting point for deriving tabulated design values for lumber grades in that species. The ultimate stress is based on the 5-percent exclusion limit for the sample of small, clear specimens. This value is established from a statistical analysis and indicates that out of all clear wood samples tested, 95 percent would be

Table 3-12.- Typical grade names for visually graded structural lumber.

Dimension Lumber	Beams and Stringers	Posts and Timbers
Structural Light Framing (LF)		
Dense Select Structural	Dense Select Structural	Dense Select Structural
Select Structural	Select Structural Dense No. 1	Select Structural
Dense No. 1	No. 1	Dense No. 1
No. 1	Dense No. 2	No. 1
Dense No. 2	No. 2	Dense No. 2
No. 2		No. 2
No.3		
Appearance		
Stud		
Joists and Planks (J&P)		
Dense Select Structural		
Select Structural		
Dense No. 1		
No. 1		
Dense No. 2		
No. 2		
No. 3		
Appearance		
Stud		
Decking		
Select Decking		
Commercial Decking		

The grade names in this table are for Douglas Fir-Larch graded to Western Wood Products Association (WWPA) rules. Other species and grading rules agencies have similar names.

expected to fail at or above the 5-percent exclusion limit, while less than 5 percent would be expected to fail below the limit. For modulus of elasticity, the small, clear value is based on the average of all sample values, rather than the 5-percent exclusion limit.

2. Clear wood properties are next adjusted for strength-reducing characteristics by strength ratios for strength properties and quality factors for modulus of elasticity (Table 3-13). Strength ratios are factors that reduce clear wood strength properties to compensate for such growth characteristics as knots, slope of grain, shake, pitch pockets, and other defects. An individual piece of lumber will often have several characteristics that affect a particular strength property. The characteristic that gives the lowest strength ratio is used to derive the estimated strength.

Strength ratio values vary for lumber grades, depending on the maximum number and location of strength-reducing characteristics permitted for the grade. For example, high-strength grades have higher strength ratios because they have more restrictive requirements on the number, type, and location of defects. Lower grades are less restrictive on strength-reducing characteristics and have lower strength ratios. For modulus of elasticity, the clear wood average value is multiplied by empirically derived quality factors to represent the reduction that occurs in lower lumber grades. The value of the quality factor for each grade is based on the value of the strength ratio for bending for that grade.

Table 3-13.- Strength ratios and quality factors for some visual grades described in the National Grading Rule.

Lumber size classification	Grade name	Strength ratio	Quality factor
Light Framing (2 to 4 in. thick, 2 to 4 in. wide)	Select Structural	0.67	1.0
	No. 1	0.55	1.0
	No. 2	0.45	0.90
	No. 3	0.26	0.80
Joists and Planks (2 to 4 in. thick, 6 in. and wider)	Select Structural	0.65	1.0
	No. 1	0.55	1.0
	No. 2	0.45	0.90
	No. 3	0.26	0.80

Sizes shown are nominal.
From *Wood Handbook*³⁰ and *ASTM D 2555*.⁷

3. In addition to strength-reducing characteristics, engineering properties for small clear samples are adjusted to compensate for differences between sample test conditions and those for the actual lumber. Specific adjustments may be made for (1) moisture content, which equates strength and modulus of elasticity for the green samples to the actual moisture content of the lumber at the time of manufacture; (2) duration of load, which equates the short 5-minute load duration used for clear sample testing to an equivalent load duration of 10 years; and (3) size adjustments for bending strength, which equate the size of the sample to the actual lumber size. In addition, each strength property except compression perpendicular to grain is adjusted by a factor of safety. Because the modulus of elasticity is judged primarily by performance criteria rather than safety criteria, a factor of safety is not applied.

For visual lumber grades, two points deserve additional emphasis. With the exception of dimension lumber (less than 5 inches thick), grade descriptions are not standardized and may vary among grading rules agencies. It is therefore possible to have lumber with the same grade name and size classification, but different tabulated strength and stiffness values. Grading also differs among different size classifications, even though the grade name may be the same. For example, lumber graded No. 1 in the B&S size classification may have more restrictive requirements for edge knots, since that classification is graded with respect to bending. For a piece graded No. 1 in P&T, edge knot requirements may be less restrictive because this size classification is graded with respect to axial loading. As a result, the bending stress for a No. 1 P&T could be less than a No. 1 B&S for the same species.

Mechanical Stress Grading

Mechanical stress grading, commonly called machine stress rating (MSR), has been used as a method of lumber grading for more than 25 years. It is based on an observed relation between modulus of elasticity (E) and the bending strength of lumber. The sorting criterion, E , is measured for individual pieces of lumber by mechanical devices that operate at high rates of speed (Figure 3-27). The E used as a sorting criterion can be measured in a variety of ways, but is usually an apparent E based on deflection. Because lumber is heterogeneous, the apparent E depends on a number of factors, including the lumber span length, orientation, mode of test, and method of loading. Any apparent E can be used, so long as the grading machine is calibrated to assign the appropriate design property. Most grading machines in the United States are designed to detect the lowest flatwise bending stiffness that occurs in any approximate 4-foot span. Although the machine-measured E is the primary sorting criterion in this grading process, MSR lumber is also subject to visual override because the size of edge knots in combination with E is a better predictor of strength than E alone. Maximum edge knots are limited to a specified proportion of the cross section, depending on the grade level. Other visual restrictions also apply to checks, shakes, splits, and warp.

Bending strength is derived by correlations with modulus of elasticity determined by the machine rating process. Assigned properties in tension and compression parallel to grain are estimated from bending strength, although some procedures estimate tension directly from E . Strengths in shear parallel to grain and in compression perpendicular to grain are assigned the same values as the equivalent species of visual lumber grades.

In the United States, the number of machine stress grades available reflects specific market needs that have developed for MSR lumber. Grade designations for MSR lumber differ from visual grades and include the tabulated strength in bending and modulus of elasticity. For example, the MSR grade 2100 F-1.8E designates a tabulated bending strength of

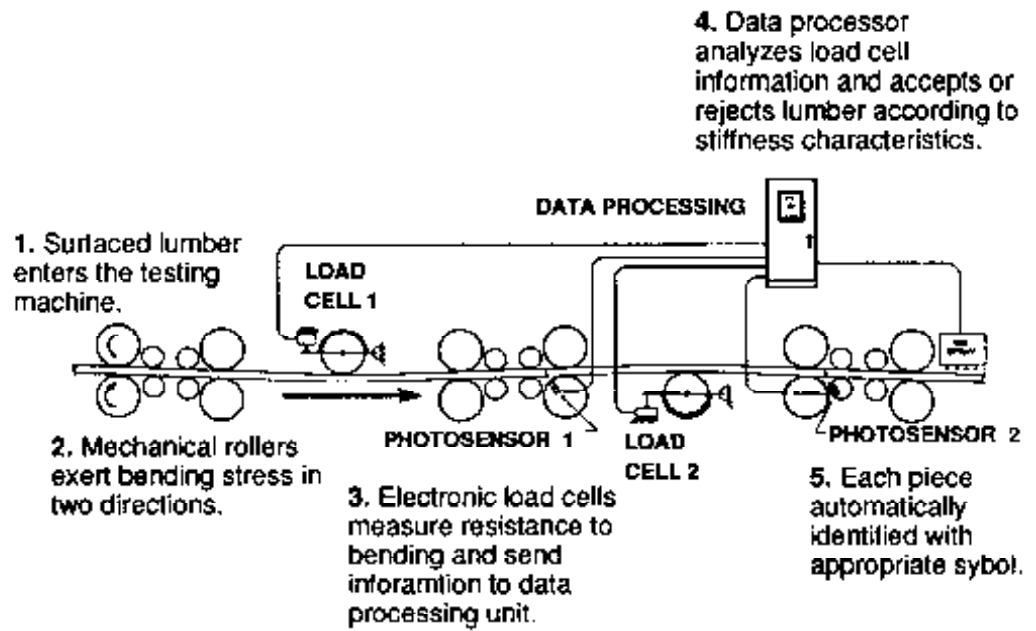

Figure 3-27.- Schematic diagram of a continuous lumber tester (CLT) used for machine stress grading lumber (courtesy of the Western Wood Products Association; used by permission).

2,100 lb/in² and a modulus of elasticity of 1.8 million lb/in², both in an edgewise orientation. Additional MSR grades are discussed in Chapter 5.

QUALITY CONTROL AND MARKING

Quality control and marking requirements for American Standard Lumber are established in the ALS PS 20-70. The ALS also includes provisions for lumber inspection and reinspection in cases where a dispute arises between buyer and seller. Responsibility for grading accuracy and certification is with the grading rules and inspection agencies that are certified by the American Lumber Standards Committee. These agencies are required to conduct regular grading inspections and spot checks at the mill to ensure grading efficiency and conformity to all established rules. When the lumber is graded in accordance with the specific grade requirements, each piece is marked to certify that the lumber conforms to the size, grade, and seasoning provisions of the rules under which it is graded. The ALS requires that these grade marks include specific information, including:

1. The lumber grade description (e.g., No. 1 for visually graded lumber or 2100f-1.8E for MSR lumber)
2. The commercial name of the lumber species or species group (e.g., Douglas Fir-Larch or Southern Pine)
3. The identification of the grading rules agency under whose rules the lumber was graded (e.g., WCLIB or SPIB)

4. The registered symbol of the certified inspection agency, when the inspection agency is different from the grading rules agency
5. The lumber moisture content at the time of surfacing: S-DRY when lumber is surfaced at a moisture content of 19 percent or less; S-GRN when lumber is surfaced at a moisture content in excess of 19 percent; KD-15 or KD-19 when the lumber is kiln dried and surfaced at a moisture content of 15 or 19 percent or less, respectively; MC-15 when the lumber is either kiln dried or dried by other means and surfaced at a moisture content of 15 percent or less
6. The designated mill number or mill name

Examples of typical lumber grade marks are shown in Figure 3-28.

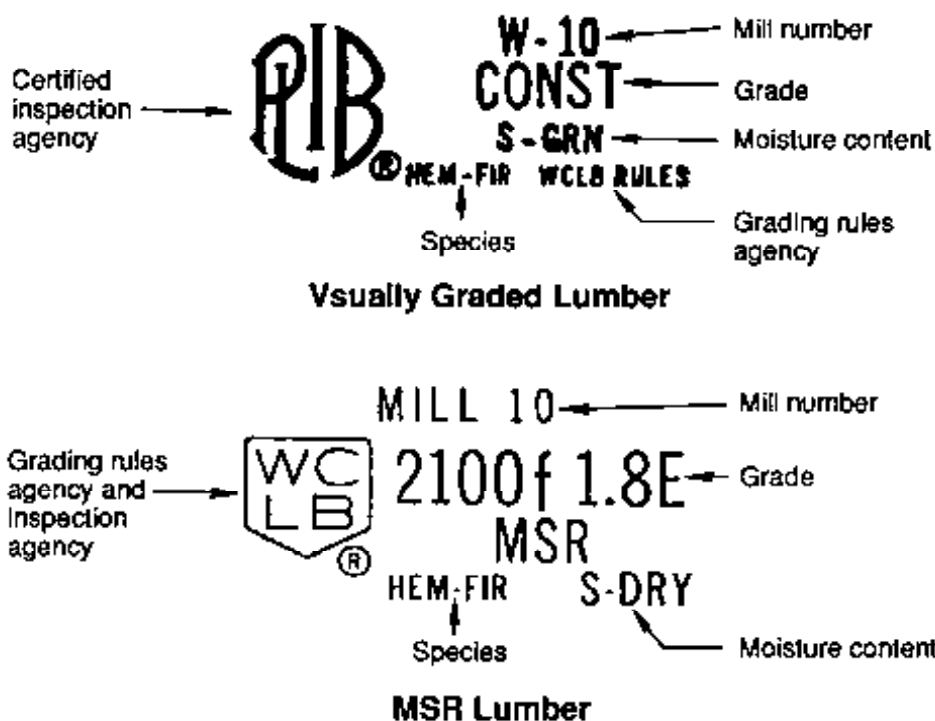

Figure 3-28.- Typical lumber grade marks.

MATERIAL SPECIFICATIONS

Accurate specifications are critical for obtaining the proper lumber for the required use. They must contain all applicable information related to the manufacture, grade, size, moisture content, and species for the required lumber. To some degree, this information must be obtained from tables of tabulated values, which are discussed in Chapter 5. The following is a summary of some of the requirements and recommendations for specifying lumber:

1. **Manufacturing Standard.** All structural lumber shall be American Standard Lumber, manufactured and graded in accordance with the latest edition of the ALS PS 20-70. Each piece shall contain a grade mark conforming to the requirements of that standard and those of the applicable grading rules agency.
2. **Species.** Lumber species or species group must be clearly stated.
3. **Grade.** Grade designations must include the commercial grade name, size classification, and the grading rules agency under which the lumber is graded.
4. **Size.** Lumber thickness and width are specified in nominal dimensions. The length in feet may be specified on the basis of the nominal average length, limiting length, or single uniform length. For some lumber, random lengths can be specified when uniform lengths are not required. In this case, upper and lower limits should also be specified.
5. **Surfacing.** Lumber surfacing is specified as dressed (surfaced all sides), rough-sawn, or full-sawn. When partial surfacing is required on one or more sides or edges of rough-sawn or full-sawn lumber, the abbreviations previously discussed are used (lumber abbreviations are also given in Chapter 16).
6. **Moisture Content.** When moisture content at the time of surfacing is important, lumber may be specified as surfaced green, surfaced dry, or kiln-dried using the same definitions described for quality control and marking.

3.7 PROPERTIES OF GLUED-LAMINATED TIMBER (GLULAM)

Glulam is an engineered, stress-rated product of a timber-laminating plant. It consists of selected and prepared lumber laminations that are bonded together on their wide faces with structural adhesive (Figure 3-29). Glulam has been used successfully as a structural material in Europe since the early 1900's. In the United States, it has been used with excellent performance in buildings since approximately 1935 and in bridges since the mid-1940's. An important point about glulam is that it is an engineered timber product rather than simply wood glued together. Laminated beams made with pieces of lumber that are nailed and glued together should not be confused with glulam.

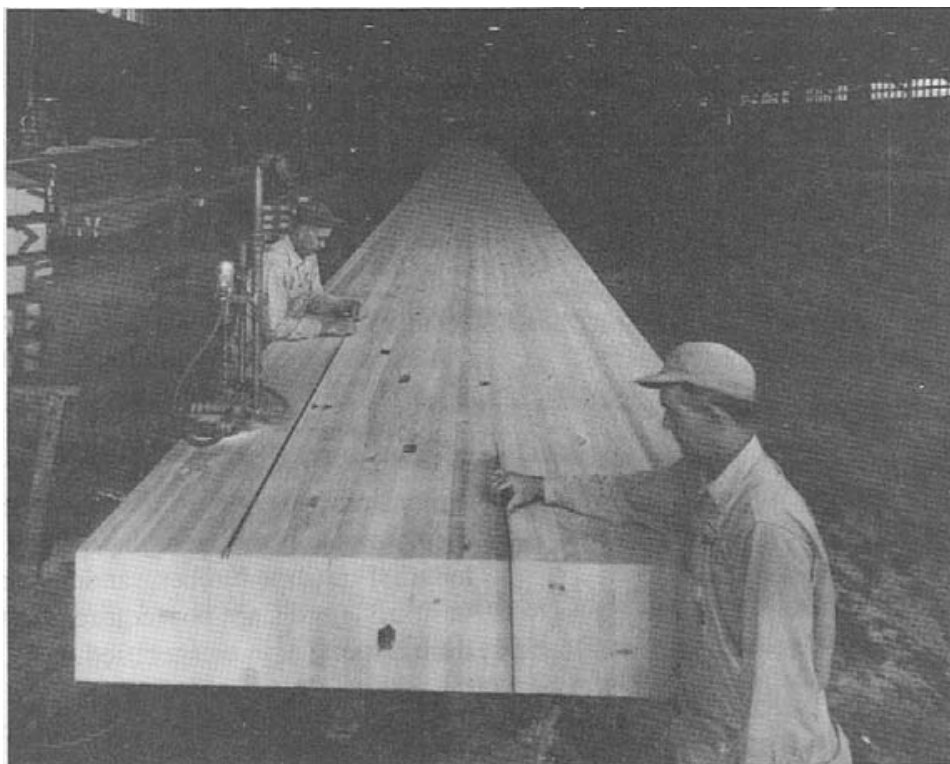

Figure 3-29.-A glulam bridge beam in the final stages of fabrication. The beam, which measures 12-1/4 inches wide, 71-1/2 inches deep and 103 feet long, required 12,800 board feet of structural grade Douglas-fir and 500 pounds of glue.

Glulam is a very versatile material that provides distinct advantages over sawn lumber. Because it is a manufactured product, glulam can be produced in a wide range of shapes and virtually any size. Most of the glulam used in bridges involves straight or slightly curved members, but curved or tapered members are used in some applications. Glulam also provides increased strength over sawn lumber because the laminating process disperses strength-reducing characteristics throughout the member (Figure 3-30). A knot in sawn lumber, for example, may substantially reduce the section and strength of a member. In glulam, the knots are distributed among the laminations so their effect at any section is minimized. Glulam also provides better dimensional stability because it is manufactured from dry lumber as compared to most large sawn lumber members, which are sawn green and seasoned after installation.

Glulam is available from a number of manufacturers strategically located across the United States. A partial listing of manufacturers is given in Chapter 16.

PRODUCT STANDARDS

The national product standard for glulam is the American National Standard for Wood Products-Structural Glued Laminated Timber, ANSI/AITC A190.1.¹ This standard, which was approved by the American National

Strength-reducing characteristics in sawn lumber can occupy much of the cross section and substantially reduce strength.

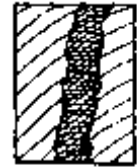
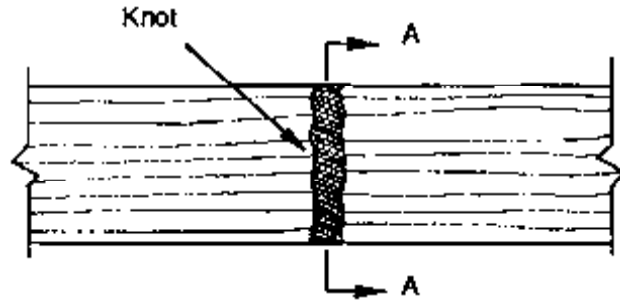

Section A-A

Laminating disperses strength-reducing characteristics, reducing their effects on strength.

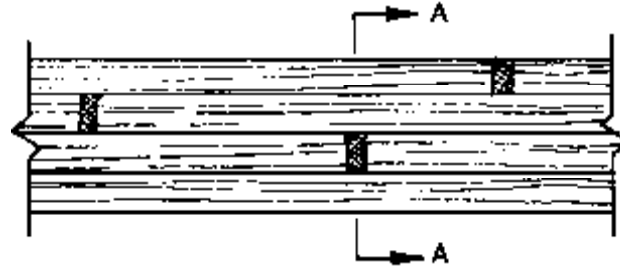

Section A-A

Figure 3-30.- Relative effects of strength-reducing characteristics on sawn lumber and glued-laminated timber.

Standards Institute (ANSI) in 1983, contains nationally recognized requirements for the production, inspection, testing, and certification of structural glulam. It also provides material producers, suppliers, and users with a basis for a common understanding of the characteristics of glulam. The requirements in ANSI/AITC A190.1 are intended to allow the use of any suitable method of manufacture that will produce a product equal or superior in quality to that specified, provided the methods of manufacture are approved in accordance with requirements of the standard.

The sponsor of ANSI/AITC A190.1 is the American Institute of Timber Construction (AITC), which is the national technical trade association of the structural glued laminating industry. Its members manufacture, fabricate, assemble, erect and/or design wood structural systems and related wood products for construction applications. AITC publishes standards related to the design, manufacture, and construction of glulam that are incorporated by reference in ANSI/AITC A190.1.

MANUFACTURING CRITERIA FOR GLULAM

Glulam can be manufactured from any softwood or hardwood lumber provided it meets necessary grading and stiffness requirements. In practice, most glulam is manufactured from two commercial species groups, western species (primarily Douglas Fir-Larch and Hem-Fir) and Southern Pine. The laminations are selected from stress-graded sawn lumber, but the lumber must be regraded using additional criteria before it can be laminating stock for glulam.¹ Lamination regrading is accomplished using either visual grading or E-rating criteria (E-rated laminations are regraded

for stiffness and edge knots as previously discussed for MSR lumber). ANSI/AITC A190.1 specifies that the moisture content of the laminations at the time of gluing not exceed 16 percent; however, moisture contents lower than 16 percent or up to 20 percent can be specified depending on the anticipated moisture content of the components in service.

The maximum lamination thickness permitted for glulam is 2 inches. The actual thickness of the laminations depends on the species of the laminations and the shape of the member. Industry standard practice is to use 2-inch nominal lumber to produce straight or slightly curved members of the type normally used for bridge construction. This results in a dressed lamination thickness of 1-1/2 inches for western species and 1-3/8 inches for Southern Pine. When sharp radius curves are required, nominal 1-inch-thick lumber (3/4-inch dressed thickness) is generally used. Lamination thickness has a significant effect on glulam economics because manufacturing costs are related to the required number of glue lines in the member. Thus, the thinner the laminations the higher the relative cost of manufacture.

Standard Glulam Sizes

Glulam is most efficiently and most economically manufactured when standard dressed lumber is used for laminations. As a result, standard glulam sizes are related to the dressed sizes for sawn lumber, but are slightly less in width to account for surfacing after the material is glued. Standard glulam widths are available in increments from 2-1/8 inches to 14-1/4 inches based on nominal lamination widths of 3 to 16 inches (Table 3-14). Note that the net widths for nominal 4-, 6-, 10-, and 12-inch laminations are different for western species and Southern Pine. Glulam depth is equal to the lamination thickness times the number of laminations, or 1-1/2 inch multiples for western species and 1-3/8-inch multiples for Southern Pine. Unlike sawn lumber, the sizes specified for glulam are the actual dimensions of the member, rather than the nominal size.

Table 3-14.- Standard widths of glulam.

Nominal width (in.)	Western species net finished width (in.)	Southern Pine net finished width (in.)
3	2-1/8	-
4	3-1/8	3
6	5-1/8	5
8	6-3/4	6-3/4
10	8-3/4	8-1/2
12	10-3/4	10-1/2
14	12-1/4	-
16	14-1/4	-

Glulam members can hypothetically be manufactured to any depth or length by simply adding more laminations. From a practical standpoint, however, the size of the member must be limited because of handling and transportation considerations. In bridge applications, another primary consideration related to member size is the size capacity of the cylinders used for pressure treatment with preservatives. Because size capabilities vary among treaters, it is recommended that the designer verify treatment capabilities prior to requiring glulam depths in excess of 60 inches or lengths in excess of 80 feet.

Glulam dimensions may vary slightly because of minor variations in manufacturing processes. Dimensional tolerances permitted at the time of manufacture are as follows:¹

1. **Width:** $\pm 1/16$ inch
2. **Depth:** $+1/8$ inch. per foot of specified depth; $-1/16$ inch per foot of specified depth, or $-1/8$ inch, whichever is greater
3. **Length:** $\pm 1/16$ inch for lengths up to 20 feet and $\pm 1/16$ inch per 20 feet of length for lengths over 20 feet, except where length dimensions are not specified or critical
4. **Squareness:** the cross section must be square within $\pm 1/8$ inch per foot of specified depth unless a specially shaped section is specified
5. **Straightness:** $\pm 1/4$ inch for beams up to 20 feet in length and $\pm 1/8$ inch per 20 feet or fraction thereof for beams greater than 20 feet in length, but not greater than a total of $\pm 3/4$ inch; tolerances intended for straight or slightly cambered beams only, not for curved members such as arches

Adhesives

Laminations for glulam are joined together with structural adhesives that are capable of developing shear strength in excess of the wood capacity. Two types of adhesives are permitted, dry-use adhesives and wet-use adhesives. Dry-use adhesives (usually casein) are allowed only when the glulam moisture content in service will not exceed 16 percent. These adhesives set or cure by the dissipation of water in the adhesive to the surrounding air and wood. Wet-use adhesives, which cure by chemical polymerization, are required for exposed uses where moisture content may exceed 16 percent in service, as in bridge applications. Wet-use adhesives are also required when laminations are chemically treated with wood preservatives before or after gluing. In practice, the wet-use adhesive phenol-resorcinol is used almost exclusively for all glulam. This adhesive can withstand severe exposure conditions and offers a manufacturing

advantage of rapid curing rates. All adhesives for glulam used in bridge applications must be wet-use adhesives.

Joints

In most cases, the size of glulam members substantially exceeds the size of available lumber, and laminations must be spliced with end joints or edge joints or both. End joints are used to splice laminations longitudinally before assembly into a glulam member. The two most common types of end joints are scarf joints and finger joints (Figure 3-31). In scarf joints, the ends of the laminations are cut at opposing slopes of 1:8 to 1:12 and are glued together on the sloping surfaces. For finger joints, ends are cut with horizontal or vertical fingers that are glued and mated together. In practice, finger joints are used almost exclusively because they require less material and are self-aligning during the gluing process.

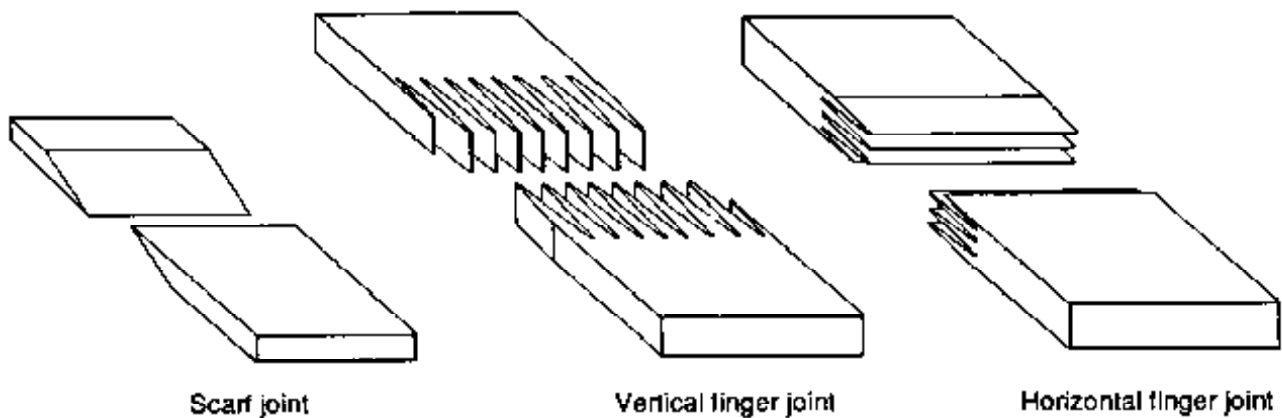

Figure 3-31.- Types of lamination end joints used in glulam.

Edge joints are required when the width of the glulam member is greater than available laminations. The most common edge joint configuration uses a staggered layup with edge joints offset between adjacent laminations (Figure 3-32). Edge joints may be glued or unglued depending on the type of member and applied stresses; however, because joint strength influences shear capacity, reduced design values for shear are required when edge joints are not glued (Chapter 5). When unglued edge joints are used for bridge members, it is recommended that edge joints in the top face be glued to prevent water and debris from becoming trapped in the joint.

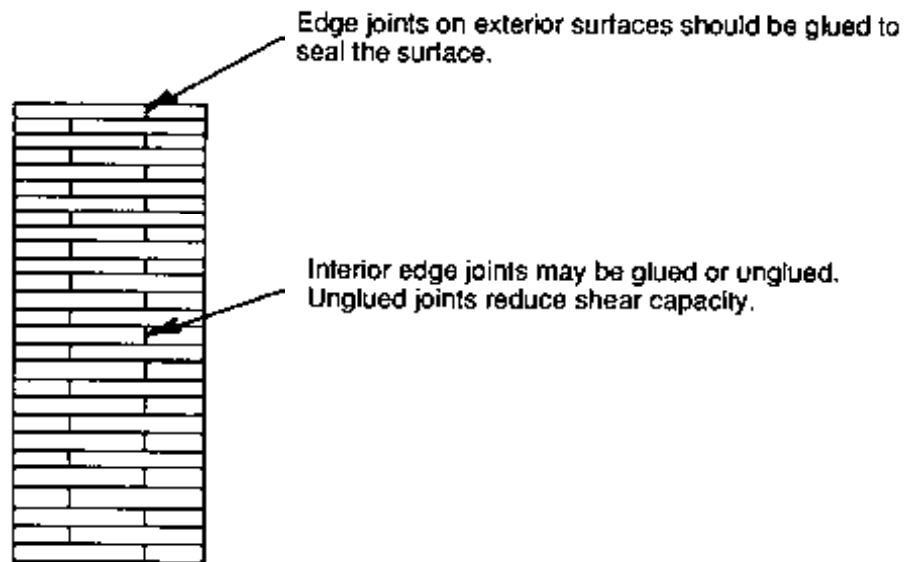

Figure 3-32.- Edge joints in a glulam member manufactured with a staggered layup.

Appearance

Glulam is available in three appearance grades: industrial, architectural, and premium. Appearance grades apply to the glulam surface and include considerations related to growth characteristics, void filling, and surfacing operations. They do not address surface treatments, stains, or varnishes, and do not alter member strength or manufacturing controls. In bridge applications, glulam is normally finished to an industrial appearance grade. An architectural grade may be used in exceptional cases where an improved appearance is required. A more complete description of appearance grades is given in AITC 110, *Standard Appearance Grades for Structural Glued-Laminated Timber*, which can be found in the *AITC Timber Construction Manual*.⁴

GRADES OF GLULAM

Glulam is not graded in the same manner as sawn lumber. Rather, members are identified by a combination symbol that represents the combination of lamination grades used to manufacture the member. These combination symbols are divided into two general classifications consisting of bending combinations and axial combinations. The classifications are similar to lumber size classifications because they are based to some degree on the anticipated use of the member. Bending combinations anticipate that the member will be used as a beam, while the axial combinations anticipate the member will be used as a column or tension member. These anticipated uses are based on criteria for the most efficient and economical use of material rather than restrictions on actual use. For both types of combinations, members may be used in any loading situation or configuration provided the resulting stresses are within allowable limits for the specific combination symbol.

Bending Combinations

Glulam bending combinations were developed to provide the most efficient and economical section for resisting bending stress caused by loads applied perpendicular to the wide faces of the laminations. The quality and strength of the laminations are varied over the member depth to provide a wide range of strengths to accommodate different loading conditions (Figure 3-33). For example, a lower grade of lamination is used for the center portion of the member where bending stress is low, while a higher grade of material is placed on the outside faces where bending stress is relatively high. Bending combinations may also be used for axial loading or for bending applied parallel to the wide face of the laminations. In these cases, however, the strength of the member is controlled by the lower grade center laminations, and the higher strength outer laminations provide little benefit. The axial combinations normally provide the most economical member for these loading conditions.

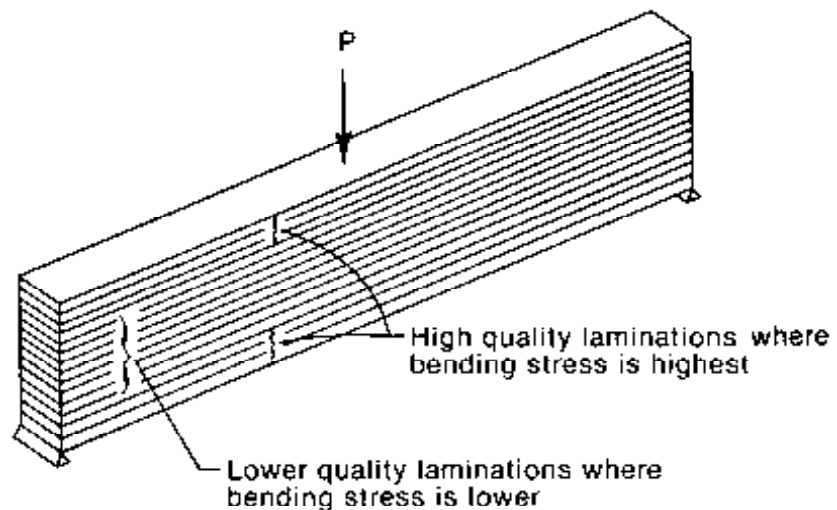

Figure 3-33.-Glulam bending combinations are intended primarily for applications where loads are applied perpendicular to the wide face of the laminations. The quality of the lumber laminations is varied over the member cross section to provide higher strength where bending stress is highest.

Combination symbols for bending combinations are specified by a series of numbers and letters that indicate the tabulated bending stress and the basis for lamination regrading. For a typical combination symbol such as 24F-V4, the 24F indicates a tabulated design stress in bending of 2,400 lb/in². Following the F, the letter V or E indicates if the combination is manufactured from visually graded or E-rated lumber, respectively. More detailed information on combination symbols and their associated design stresses is provided in Chapter 5.

Axial Combinations

Glulam axial combinations were developed to provide the most efficient and most economical section for resisting axial forces and bending stress applied parallel to the wide faces of the laminations (Figure 3-34). Unlike bending combinations, the same grade of lamination is used throughout the member. Axial combinations may also be loaded perpendicular to the wide face of the laminations, but the nonselective material placement often results in a less efficient and less economical member than the bending combination. Combination symbols for axial combinations are unrelated to strength or lamination grading and consist of a numerical value only. Examples include combination symbol 1 and combination symbol 47.

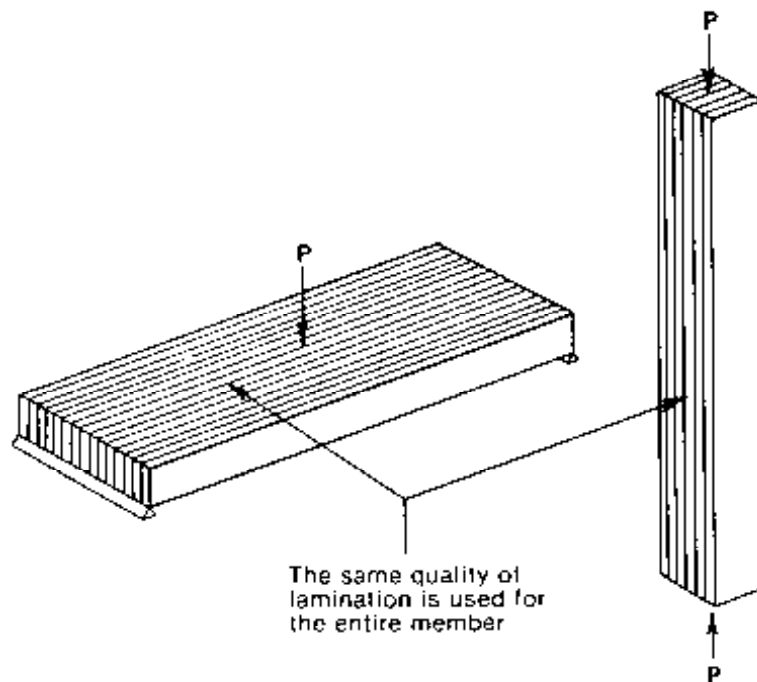

Figure 3-34.- Glulam axial combinations are intended primarily for applications where loads are applied parallel to the wide face of the laminations. The same quality of lumber lamination is used for the entire member.

QUALITY CONTROL AND MARKING

ANSI/AITC A190.1 requires that each glulam manufacturer maintain a strict quality control program for the production of glulam. This program must include continuing inspection and evaluation in areas related to manufacturing procedures, material testing, and quality control records. The inspections must be supervised by an independent third party to the manufacturer that meets specific qualification requirements outlined in the standard. The AITC operates a continuing quality program for its

members; however, any independent inspection agency may be used, provided it meets the requirements of the ANSI/AITC standard.

To indicate compliance with quality control requirements, each glulam member must be distinctively marked. Marking requirements are given in ANSI/AITC A190.1 for two types of glulam products, custom products and noncustom products. Custom products, which are used almost exclusively in bridge applications, are manufactured to specific specifications for a known use. Noncustom products are manufactured in accordance with ANSI/AITC A190.1, but are not intended for a particular use (they are usually stock members maintained by a supplier for any applicable use). Marking for custom and noncustom products must include (1) identification that the glulam was manufactured in accordance with the requirements of ANSI/AITC A190.1, (2) identification of the qualified inspection and testing agency, and (3) identification of the laminating plant. Marking for noncustom products must also include additional information outlined in ANSI/AITC A190.1 (Figure 3-35). For all glulam, ANSI/AITC A190.1 also requires that a certificate of material conformance be issued when requested by the purchaser. It is recommended that such a certificate be required for all bridge members, because treatment of the member with preservatives often makes the quality mark difficult or impossible to read.

In addition to quality marks, straight or slightly curved glulam beams must be stamped **TOP** at both ends to indicate the proper orientation of the beam. Because the bending strength of glulam beams is often different for the tension and compression zones, this marking is important to ensure that the member is correctly placed.

MATERIAL SPECIFICATIONS

Glulam can be specified by combination symbol or by minimum required values for strength and stiffness (bending, shear, compression, and so forth). In both cases, familiarity with available combination symbols, tabulated design values, and modification factors is required. These items are discussed in detail in Chapter 5, as are glulam specification examples. At this point, however, it is important that the designer understand the basics of glulam specification summarized as follows:

1. **Manufacturing Standard.** Materials, manufacture, and quality control for glulam shall be in conformance with the latest edition of ANSI/AITC A190.1, Structural Glued Laminated Timber.
2. **Laminating Combinations.** It is recommended that combination symbols requiring E-rated laminations be specified only after availability is verified. Visually graded material should be specified with an E-rated substitution permitted when material is available.

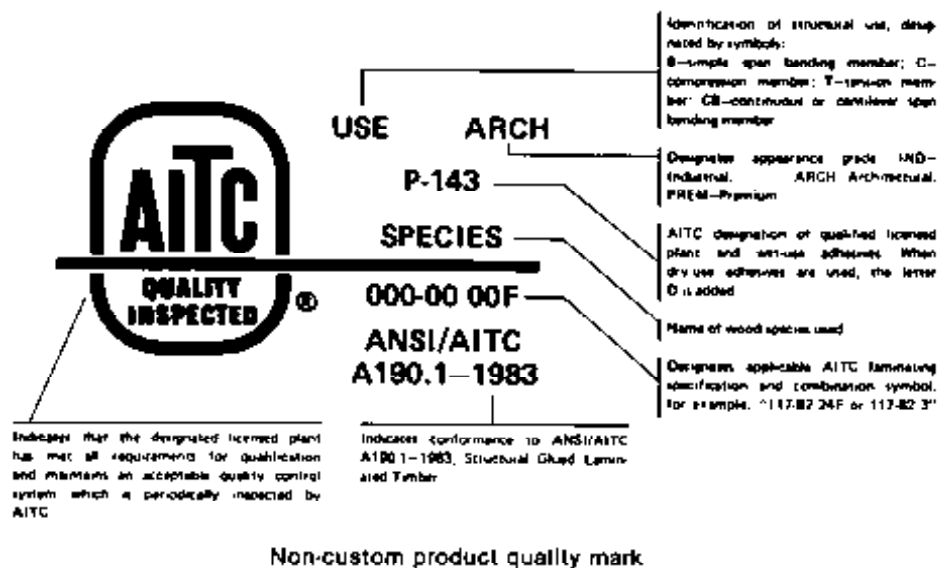
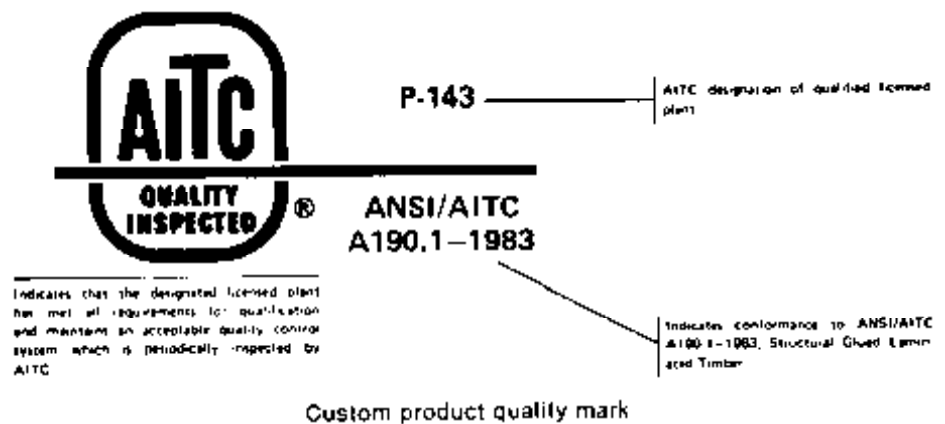

Figure 3-35.- Typical glulam quality marks for custom and noncustom products. These marks are issued through the AITC quality program. Other types of marks with the same information may be used by other agencies (photo courtesy of the American Institute of Timber Construction; used by permission).

3. **Lamination Species.** The species or species group of lamination must be specified because the same combination symbol may be applicable to both western species and Southern Pine.
4. **Size.** Glulam members are specified by the actual member size rather than the nominal size commonly used for sawn lumber. Section properties for standard glulam sizes are given in Chapter 16.

5. **Adhesives.** All glulam manufactured for bridge applications shall use wet-use adhesives.
6. **Moisture Content.** The moisture content of glulam at manufacture is 16 percent or less. In arid regions where the equilibrium moisture content in service is expected to be significantly less, a lower glulam moisture content (as low as 10 percent) can be specified to minimize the potential for checking in service.
7. **Appearance.** Glulam shall be manufactured to industrial appearance unless aesthetic considerations warrant an improved surface condition.
8. **Quality Marks and Certificates.** Glulam members shall be marked with a quality mark and provided with a certificate of conformance to indicate conformance with ANSI/AITC A190.1, Structural Glued Laminated Timber.

3.8 SELECTED REFERENCES

1. American Institute of Timber Construction. 1983. American national standard for wood products-structural glued laminated timber. ANSI/AITC A190.1. Englewood, CO: American Institute of Timber Construction. 16 p.
2. American Institute of Timber Construction. 1987. Design standard specifications for structural glued laminated timber of softwood species. AITC 117-87-Design. Englewood, CO: American Institute of Timber Construction. 28 p.
3. American Institute of Timber Construction. 1973. Inspection manual. AITC 200-73. Englewood, CO: American Institute of Timber Construction. 33 p.
4. American Institute of Timber Construction. 1985. Timber construction manual. 3d ed. New York: John Wiley and Sons, Inc. 836 p.
5. American Lumber Standards Committee. 1982. Certified agencies and typical grade stamps. Germantown, MD: American Lumber Standards Committee. 4 p.
6. American Society for Testing and Materials. [See current edition.] Standard methods for estimating structural grades for visually graded lumber. ASTM D 245. Philadelphia, PA: ASTM.
7. American Society for Testing and Materials. [See current edition.] Standard methods for establishing clear wood strength values. ASTM D 2555. Philadelphia, PA: ASTM.
8. American Society of Civil Engineers. 1975. Wood structures, a design guide and commentary. New York: American Society of Civil Engineers. 416 p.

9. Barnes, H.M.; Winandy, J.E. 1986. Effects of seasoning and preservatives on the properties of treated wood. *Proceedings of the American Wood Preservers' Association* 82: 95-105.
10. Bodig, J.; Goodman, J.R. 1973. Prediction of elastic parameters for wood. *Wood Science* 5(4): 249-264.
11. Canadian Wood Council. 1985. Canadian wood construction. Glued laminated timber specifications. CWC datafile WS-2. Ottawa, Can.: Canadian Wood Council. 12 p.
12. Canadian Wood Council. 1985. Canadian wood construction. Lumber specifications. CWC datafile WS-1. Ottawa, Can.: Canadian Wood Council. 20 p.
13. Canadian Wood Council. 1986. Canadian wood construction. Structure and properties. CWC datafile SP-1. Ottawa, Can.: Canadian Wood Council. 16 p.
14. Ethington, R.L.; Galligan, W.L.; Montrey, H.M.; Freas, A.D. 1979. Evolution of allowable stresses in shear for lumber. Gen. Tech. Rep. FPL 23. Madison, WI: U.S. Department of Agriculture, Forest Service, Forest Products Laboratory. 16 p.
15. Galligan, W.L.; Snodgrass, D.V.; Crow, G.W. 1977. Machine stress rating: practical concerns for lumber producers. Gen. Tech. Rep. FPL 7. Madison, WI: U.S. Department of Agriculture, Forest Service, Forest Products Laboratory. 83 p.
16. Gerhards, C.C. 1977. Effect of duration and rate of loading on strength of wood and wood-based materials. Res. Pap. FPL-283. Madison, WI: U.S. Department of Agriculture, Forest Service, Forest Products Laboratory. 24 p.
17. Gerhards, C.C. 1982. Effect of moisture content and temperature on the mechanical properties of wood: An analysis of immediate effects. *Wood and Fiber* 14(1): 4-36.
18. Gerhards, C.C. 1979. Time-related effects of loading on wood strength: a linear cumulative damage theory. *Wood Science* 11(3): 139-144.
19. Green, D.W.; Evans, J.W. 1987. Mechanical properties of visually graded lumber: Volume 1, a summary. Madison, WI: U.S. Department of Agriculture, Forest Service, Forest Products Laboratory. 131 p.
20. Green, D.W.; Evans, J.W. 1988. Moisture content-property relationships for dimension lumber: decisions for the future. For publication in the proceedings of the Workshop on In-Grade Testing of Structural Lumber; 1988; April 25-26, Madison, WI.
21. Gurfinkle, G. 1981. *Wood engineering*. 2d ed. Dubuque, IA: Kendall/Hunt. 552 p.
22. Millett, M.A.; Gerhards, C.C. 1972. Accelerated aging: residual weight and flexural properties of wood heated in air at 115 to 175 °C. Madison, WI: *Wood Science* 4(4).
23. National Forest Products Association. 1986. Design values for wood construction. A supplement to the national design specification for wood construction. Washington, DC: National Forest Products Association. 34 p.

24. National Forest Products Association. 1986. National design specification for wood construction. Washington, DC: National Forest Products Association. 87 p.
25. National Forest Products Association. 1980. Wood structural design data. Washington, DC: National Forest Products Association. 240 p.
26. Salmon, S.G.; Johnson, J.E. 1980. Steel structures, design and behavior. 2d ed. New York: Harper & Row. 1007 p.
27. Southern Pine Inspection Bureau. 1977. Grading Rules. Pensacola, FL: Southern Pine Inspection Bureau. 222 p.
28. U.S. Department of Agriculture, Forest Service, Forest Products Laboratory. 1981. Wood: Its structure and properties. Wangaard, F.F., ed. Clark C. Heritage Memorial Series on Wood. Compilation of educational modules; 1st Clark C. Heritage Memorial Workshop; 1980, August; Madison, WI. University Park, PA: The Pennsylvania State University. Vol. 1. 465 p.
29. U.S. Department of Agriculture, Forest Service, Forest Products Laboratory. 1982. Wood as a structural material. Dietz, A.G.H.; Schaffer, E.L.; Gromala, D.S., eds. Clark C. Heritage Memorial Series on Wood. Compilation of educational modules; 2d Clark C. Heritage Memorial Workshop; 1980, August; Madison, WI. University Park, PA: The Pennsylvania State University. Vol. 2. 282 p.
30. U.S. Department of Agriculture. 1987. Wood handbook: wood as an engineering material. Agric. Handb. No. 72. Madison, WI: U.S. Department of Agriculture, Forest Service, Forest Products Laboratory. 466 p.
31. U.S. Department of Commerce, National Bureau of Standards. 1970. American softwood lumber standard. Voluntary Prod. Stand. PS 20-70. Washington, DC: U.S. Department of Commerce, National Bureau of Standards. 26 p.
32. West Coast Lumber Inspection Bureau. 1984. West coast lumber standard grading rules. No. 16. Portland, OR: West Coast Lumber Inspection Bureau. 223 p.
33. Western Wood Products Association. 1984. Grade stamp guide. WWPA tech. guide TG-6. Portland, OR: Western Wood Products Association. 2 p.
34. Western Wood Products Association. 1981. Western lumber grading rules. Portland, OR: Western Wood Products Association. 222 p.
35. Western Wood Products Association. 1985. Western lumber product use manual. Portland, OR: Western Wood Products Association. 19 p.
36. Western Wood Products Association. 1983. Western woods use book. 3d ed. Portland, OR: Western Wood Products Association. [350 p.]
37. Winandy, J.E. 1987. Effects of treatment and redrying on the mechanical properties of wood. Proceedings of the Forest Products Research Society on Wood Protection Techniques and the use of Treated Wood in Construction; 1987 October 28-30; Memphis, TN. Madison, WI: Forest Products Research Society. [100 p.].